

DSP9200 Series Wheel Balancer



HUNTER
Engineering Company

CONTENTS

| | |
|---|-----------|
| 1. GETTING STARTED | 1 |
| 1.1 Introduction | 1 |
| References | 1 |
| 1.2 For Your Safety | 1 |
| Hazard Definitions | 1 |
| IMPORTANT SAFETY INSTRUCTIONS | 2 |
| Electrical | 3 |
| Decal Information and Placement | 4 |
| Right Side View | 4 |
| Left Side View | 5 |
| Back View | 6 |
| Specific Precautions/Power Source | 7 |
| Turning Power ON/OFF | 7 |
| Equipment Installation and Service | 7 |
| Equipment Specifications | 8 |
| Safety Summary | 8 |
| Explanation of Symbols | 8 |
| 1.3 DSP9200 Components | 9 |
| Standard Accessories | 10 |
| 1.4 Operating the Control Panel | 11 |
| Control Panel | 11 |
| Using the Control Panel | 11 |
| Using Wheel Dimension Control Knobs | 12 |
| 2. BALANCING OVERVIEW | 13 |
| 2.1 Balancing Modes | 13 |
| Static Balance | 13 |
| Dynamic Imbalance | 14 |
| Static and Dynamic Imbalance Sensitivity | 15 |
| 2.2 Identifying the Static Balance Weight Plane | 15 |
| 2.3 Identifying the Dynamic Balance Weight Planes | 16 |
| 2.4 On-Vehicle Wheel Mounting Methods | 18 |
| Hub Centric | 18 |
| Lug Centric | 18 |
| 3. BALANCING A WHEEL | 19 |
| 3.1 Mount the Wheel on the Spindle Shaft | 19 |
| Front/Back Cone Mounting | 20 |
| Using Plastic Wheel Mounting Washer | 21 |
| Cone/Flange Plate Mounting | 23 |
| Using the Pressure Ring and Spacers | 24 |
| Pressure Ring | 24 |
| Spacers | 24 |
| CenteringCheck® | 25 |
| 3.2 Measuring the Wheel with Inner and Outer Auto Dataset® Arms | 26 |
| Measuring Dimensions for Clip-On Weights: | 26 |
| Mixed Weights and Two Adhesive Weights (Inputting Distance and Diameter for Both Planes): | 27 |
| 3.3 Manually Setting Wheel Dimensions | 28 |
| Measuring the Wheel at the Inner Rim Lip (Clip-On Weight) | 29 |
| Measuring Wheel Width with Rim Width Calipers | 30 |
| Measuring the Inside Wheel Surface with the Pointer Disk Edge (Adhesive Tape-On Weights) | 30 |

| | |
|--|-----------|
| Measuring the Inside Wheel Diameters (For Adhesive Weights) | 31 |
| 3.4 Locating the Wheel Weights at the Top Dead Center (“TDC”) and Bottom Dead Center (“BDC”) | 32 |
| 3.5 Standard Balancing Procedure (Clip-on Weights) | 33 |
| 3.6 Static / Standard Balancing Procedure (Clip-on Weight) | 35 |
| 3.7 Adhesive Weight Procedures (Combination of Clip-on & Adhesive Weights, or Two Adhesive)..... | 36 |
| 3.8 Static / ALU Balancing Procedure (Adhesive Weight) | 41 |
| 3.9 OPT-1 Optimizing Tire & Wheel Imbalances (Wheel with the Tire Mounted Procedure)..... | 42 |
| 3.10 OPT-2 Optimizing Tire & Wheel Imbalances (Tire Not Mounted Procedure) | 43 |
| 3.11 Patch Balance® Procedures | 44 |
| Static Patch Balance® (Single Weighted Balance Patch) | 44 |
| Dynamic Patch Balance® (Two Weighted Balance Patches) | 45 |
| 4. BALANCING FEATURES AND OPTIONS | 47 |
| 4.1 Servo-Stop..... | 47 |
| Servo-Stop Wheel Weight Positioning..... | 47 |
| Disabling Servo-Stop..... | 47 |
| Turning On Servo-Stop..... | 47 |
| Servo-Stop Aided Clip-On Weight Placement | 47 |
| Servo-Stop Aided Adhesive Weight Placement..... | 47 |
| 4.2 Locate the Adhesive Wheel Weights Using the Dataset® Arm Pointer Disk Edge..... | 48 |
| Inside of Wheel (Single Row of Adhesive Weights)..... | 48 |
| Inside of Wheel (Double Row of Adhesive Weights) | 48 |
| 4.3 Quick-Thread™ Feature..... | 49 |
| 4.4 Motor Drive/Servo-Stop | 49 |
| Servo-Stop/Servo-Push | 49 |
| 4.5 Spindle-Lok® Feature | 50 |
| 4.6 Hood Close Autostart Feature | 50 |
| 4.7 Loose Hub Detect Feature | 50 |
| 4.8 Blinding and Rounding | 51 |
| 4.9 Split Weight® Feature | 51 |
| Split Weight® Operation | 52 |
| Correcting Large Imbalances..... | 52 |
| 4.10 Split Spoke® Feature | 53 |
| Re-entering Similar Wheel after Split Spoke® is Enabled..... | 53 |
| Placing Hidden Weight Forward of Obstructions | 54 |
| 4.11 Automatic Weight Recalculation and Dimension Preservation | 55 |
| 4.12 Storing and Recalling Wheels | 55 |
| Storing a Wheel into Memory..... | 55 |
| Recalling a Wheel from Memory..... | 55 |
| 5. MAINTENANCE AND CALIBRATION..... | 57 |
| 5.1 Cleaning the Unit..... | 57 |
| 5.2 Spindle Hub Face and Shaft Maintenance..... | 57 |
| 5.3 Mounting Cone Maintenance | 57 |
| 5.4 Identifying Software Version and Serial Number | 57 |
| 5.5 Calibration Procedures | 58 |
| Quick Cal Check | 58 |
| Balancer Calibration..... | 59 |
| Inner Dataset® Arm (Calibration Tool, 221-672-1, Required) | 60 |
| Outer Dataset® Arm (Calibration Tool, 221-672-1, Required) | 62 |
| 6. GLOSSARY | 63 |

1. GETTING STARTED

1.1 Introduction

This manual provides operation instructions and information required to operate the DSP9200 Wheel Balancer. Read and become familiar with the contents of this manual prior to operating the DSP9200.

The owner of the DSP9200 is solely responsible for arranging technical training. The DSP9200 is to be operated only by a qualified, trained technician. Maintaining records of personnel trained is solely the responsibility of the owner and management.

References

This manual assumes that you are already familiar with the basics of tire balancing. The first section provides the basic information needed to operate the DSP9200. The following sections contain detailed information about equipment operation and procedures. *Italics* are used to refer to specific parts of this manual that provide additional information or explanation. For example, *Refer to "Equipment Components," page 9*. These references should be read for additional information to the instructions being presented.

1.2 For Your Safety

Hazard Definitions

Watch for these symbols:

 **CAUTION:** Hazards or unsafe practices, which could result in minor personal injury or product or property damage.

 **WARNING:** Hazards or unsafe practices, which could result in severe personal injury or death.

 **DANGER:** Immediate hazards, which will result in severe personal injury or death.

These symbols identify situations that could be detrimental to your safety and/or cause equipment damage.

IMPORTANT SAFETY INSTRUCTIONS

Read all instructions before operating the DSP9200.

Do not operate equipment with a damaged cord or equipment that has been dropped or damaged until a Hunter Service Representative has examined it.

Always unplug equipment from electrical outlet when not in use. Never use the cord to pull the plug from the outlet. Grasp plug and pull to disconnect.

If an extension cord is necessary, a cord with a current rating equal to or more than that of the equipment should be used. Cords rated for less current than the equipment may overheat. Care should be taken to arrange the cord so that it will not be tripped over or pulled.

Verify that the electrical supply circuit and the receptacle are properly grounded.

To reduce the risk of electrical shock, do not use on wet surfaces or expose to rain. Never direct a hose stream at equipment when cleaning.

Verify the appropriate electrical supply circuit is the same voltage and amperage ratings as marked on the balancer before operating.

 **WARNING: DO NOT ALTER THE ELECTRICAL PLUG. Plugging the electrical plug into an unsuitable supply circuit will damage the equipment and may result in personal injury.**

To reduce the risk of fire, do not operate equipment near open containers of flammable liquids or sprays (gasoline, cleaners, fluids, etc.).

Read and follow all caution and warning labels affixed to your equipment and tools. Misuse of this equipment can cause personal injury and shorten the life of the balancer.

Keep all instructions permanently with the unit.

Keep all decals, labels, and notices clean and visible.

To prevent accidents and/or damage to the balancer, use only Hunter DSP9200 recommended accessories.

Use equipment only as described in this manual.

Never stand on the balancer.

Wear non-slip safety footwear when operating the balancer.

Keep hair, loose clothing, neckties, jewelry, fingers, and all parts of body away from all moving parts.

Do not place any tools, weights, or other objects on the safety hood while operating the balancer.

ALWAYS WEAR OSHA APPROVED SAFETY GLASSES. Eyeglasses that have only impact resistant lenses are not safety glasses.

Keep the safety hood and its safety interlock system in good working order.

Verify that the wheel is mounted properly and that the wing nut is firmly tightened before spinning the wheel.

Hood Autostart will cause the balancer shaft to spin automatically upon hood closure. For the next Autostart, the safety hood has to be lifted to the full up position and then closed.

Raise safety hood only after wheel has come to a complete stop. If safety hood is raised before the spin is completed, the weight values will not be displayed.

Do not let cord hang over any edge or contact fan blades or hot manifolds.

SAVE THESE INSTRUCTIONS.

Electrical

The DSP9200 is manufactured to operate at a specific voltage and amperage rating.

Make sure that the appropriate electrical supply circuit is of the same voltage and amperage ratings as marked on the balancer.

 **WARNING: DO NOT ALTER THE ELECTRICAL PLUG. Plugging the electrical plug into an unsuitable supply circuit will damage the equipment.**

Make sure that the electrical supply circuit and the appropriate receptacle is installed with proper grounding.

To prevent the possibility of electrical shock injury or damage to the equipment when servicing the balancer, power must be disconnected by removing the power cord from the electrical power outlet.

After servicing, be sure the balancer ON/OFF switch is in the "O" (off) position before plugging the power cord into the electrical power outlet.

This device is rated as Class A for radiated emissions.

In the event of radio interference, the display read out may flicker - this is normal.

Decal Information and Placement

NOTE: Decals and their placement may vary due to balancer configuration and options.

Right Side View

Decal 128-963-2 gives the maximum wheel diameter, maximum wheel weight, and maximum rotational frequency for the DSP9200.

Decal 128-605-2-00 cautions the user that spindle rotation may occur with foot pedal depression and to keep clear of clamping components during Quick-Thread™ shaft rotation.

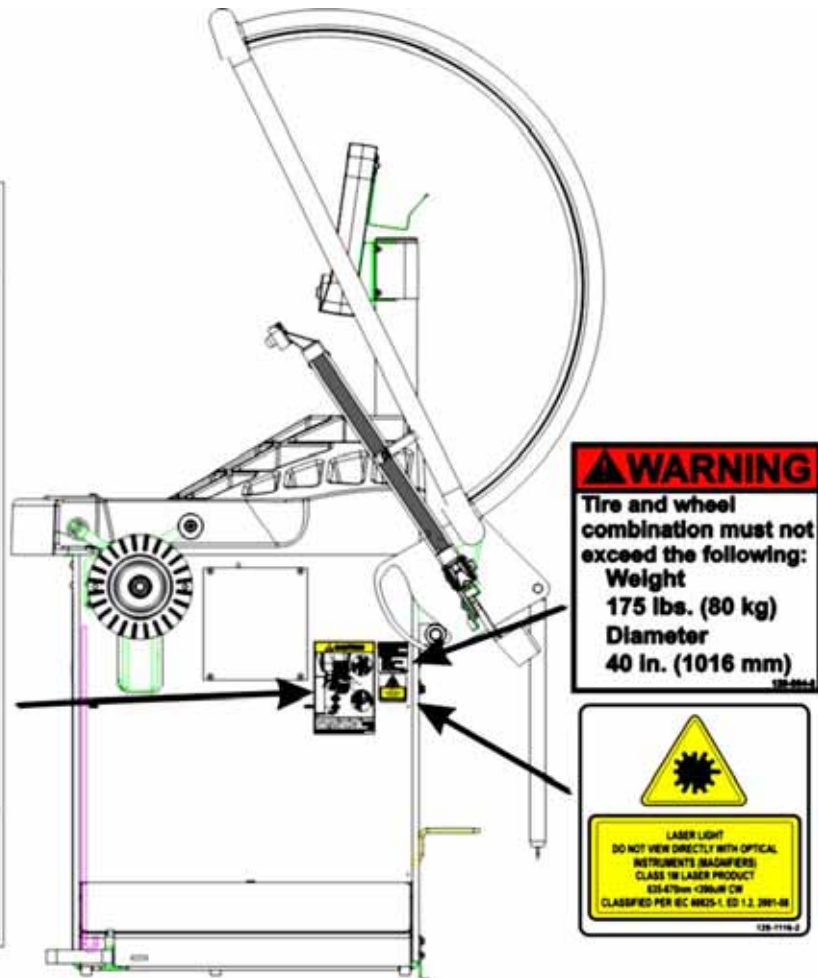
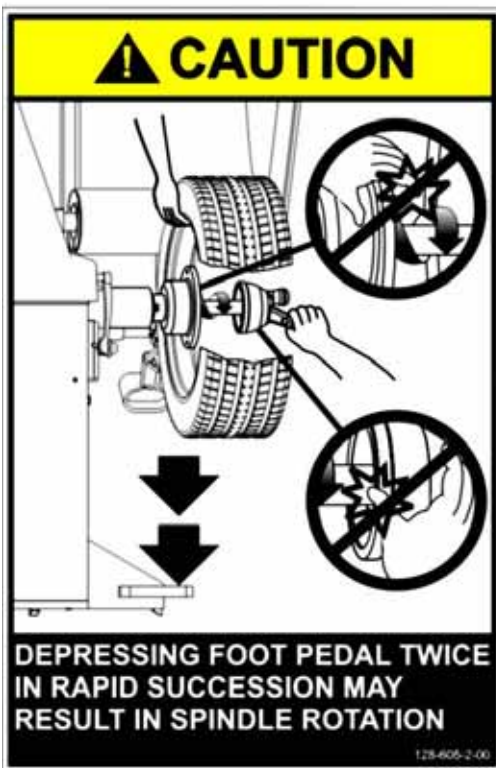

Left Side View

Decal 128-391-2-00 cautions that the unit may automatically start upon closing of the hood when hood Autostart is enabled.

Decal 128-229-2 and decal 128-905-2 work in conjunction to caution the user to not remove the screw because of the risk of electrical shock.

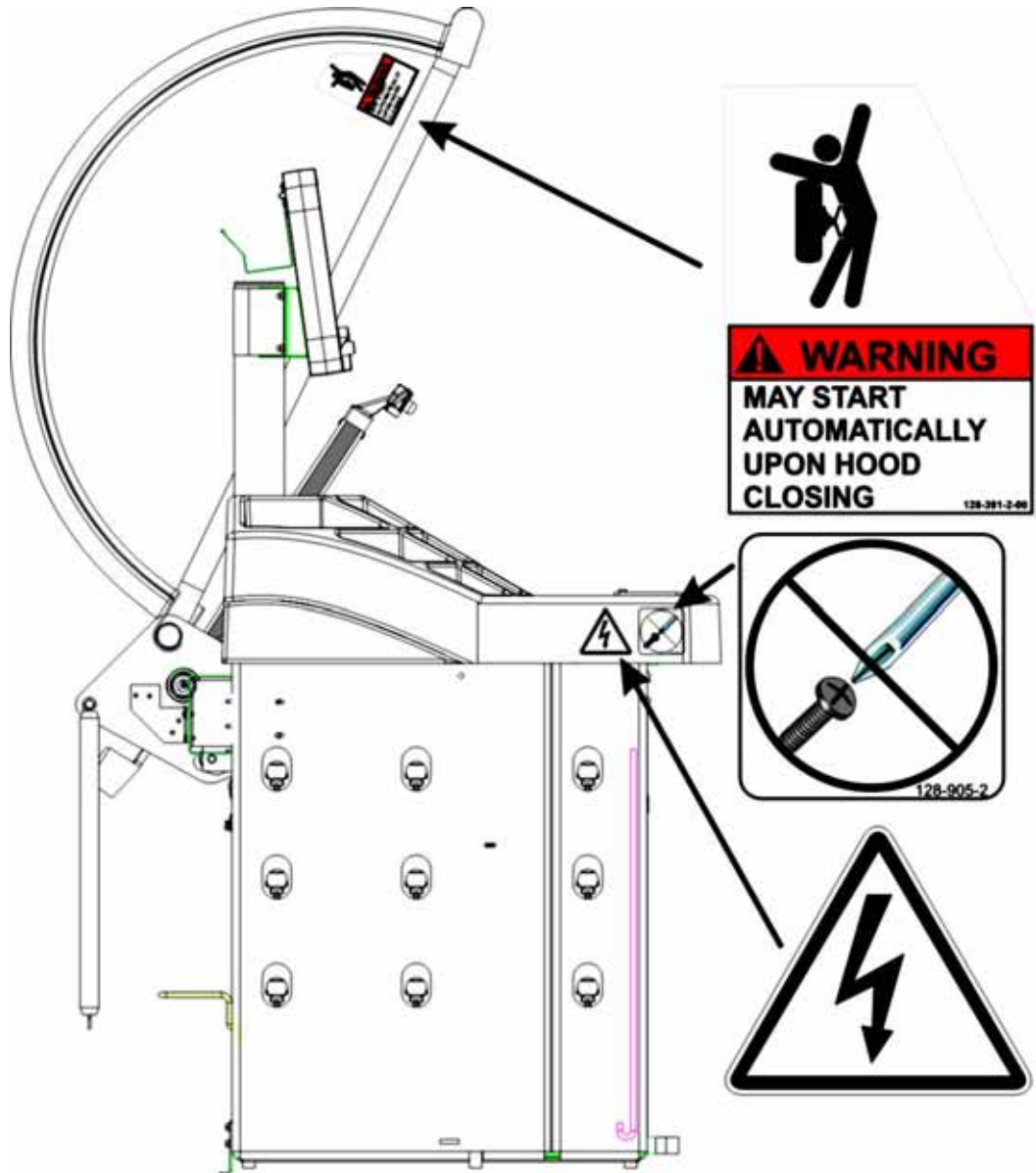

Back View

Decal 128-907-2 warns the user to place the DSP9200 at garage floor level, and not in a recessed area, to avoid the possibility of flammable fume ignition.

Decal 128-229-2 and decal 128-905-2 work in conjunction to caution the user to not remove the screw because of the risk of electrical shock.

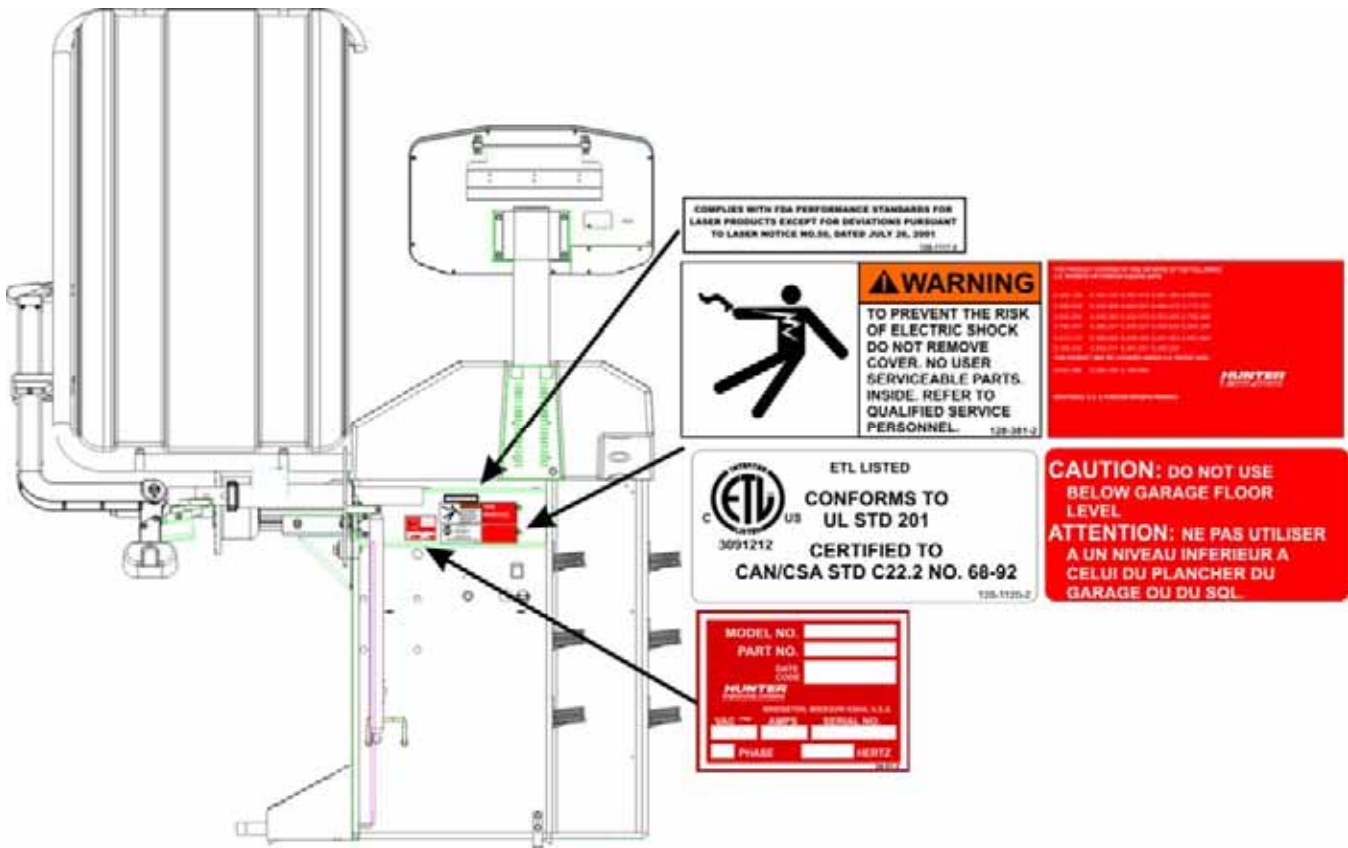

Specific Precautions/Power Source

The DSP9200 is intended to operate from a power source that will apply 230VAC +10% / -15%, 1 phase, 3 amp 50/60 Hz, *power cable includes* NEMA 20 amp plug, L6-20P, between the supply conductors of the power cord. The power cord supplied utilizes a twist lock connector, NEMA L6-20P. This machine must be connected to a 20 amp branch circuit. Please refer all power source issues to a certified electrician. Refer to Form 5467T, "Installation Instructions for DSP9200 Wheel Balancer."

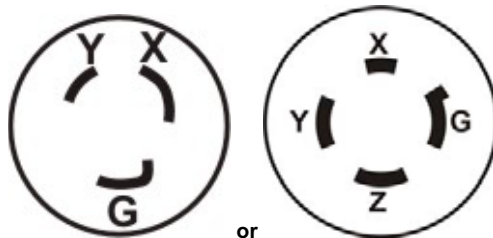

⚠ CAUTION: A protective ground connection, through the grounding conductor in the power cord, is essential for safe operation. Use only a power cord that is in good condition.

NOTE: For information on converting from single phase NEMA L6-20P plug to three phase NEMA L15-20P plug refer to Form 5350T, "NEMA L6-20P to NEMA L15-20P Power Plug Conversion Instructions."

Turning Power ON/OFF

The ON/OFF switch is located on the back of the balancer cabinet. To turn the balancer "ON," press the "I" side of the ON/OFF switch. To turn the balancer "OFF," press the "O" side of the ON/OFF switch.

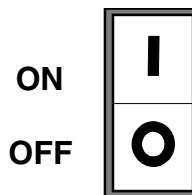

When the ON/OFF switch is turned "ON," the display panel segments will begin lighting individually from left to right presenting a merchandising display. This also indicates that power is on, the unit has self-checked, and that all displays are functioning. Pressing any button on the control panel or moving the spindle shaft will exit the merchandising display and advance the balancer to the default settings: STANDARD procedure / DYNAMIC mode with the "Blind" and "Rounding" enabled. Refer to "Blinding and Rounding," page 51.

Equipment Installation and Service

Installation should be performed by a factory-authorized representative.

This equipment contains no user serviceable parts. All repairs must be referred to a qualified Hunter Service Representative.

Equipment Specifications

Electrical

| | |
|-----------|---|
| Voltage: | 230VAC +10% / -15%, 1 phase, 50/60 Hz, <i>power cable includes</i> NEMA 20 amp plug, L6-20P |
| Amperage: | 3 amperes |
| Wattage: | 920 watts (peak) |

Atmospherics

| | |
|----------------------|---|
| Temperature: | +32°F to +122°F (0°C to +50°C) |
| Relative Humidity: | Up to 95% Non-condensing |
| Altitude: | Up to 6000 ft. (1829 m) |
| Sound Pressure Level | Equivalent continuous A-weighted sound pressure at operator's position does not exceed 70 dB (A). |

Safety Summary

Explanation of Symbols

These symbols may appear on the equipment.



Alternating current.



Earth ground terminal.



Protective conductor terminal.



ON (supply) condition.



OFF (supply) condition.



Risk of electrical shock.



Stand-by switch.



Not intended for connection to public telecommunications network.

1.3 DSP9200 Components

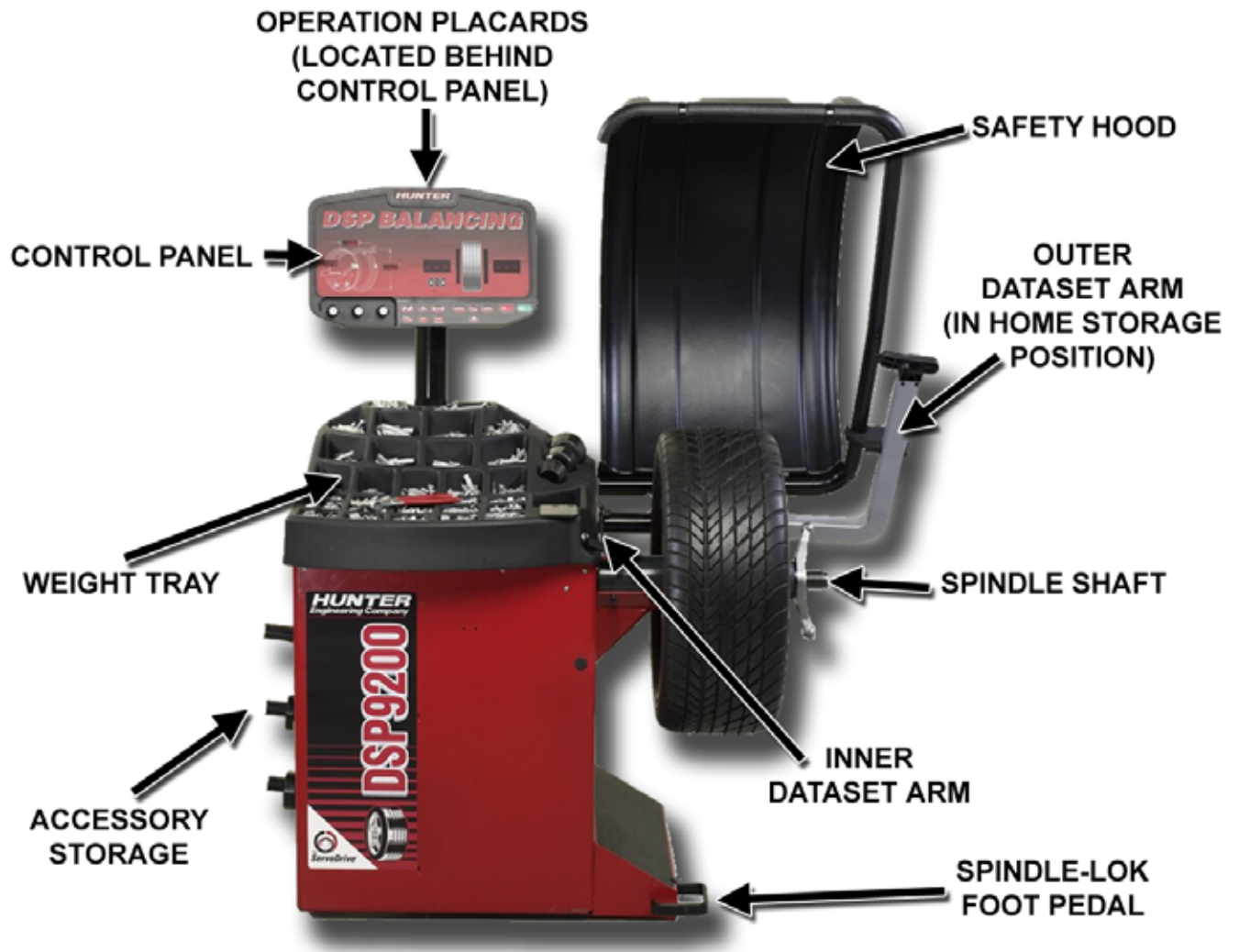

Standard Accessories

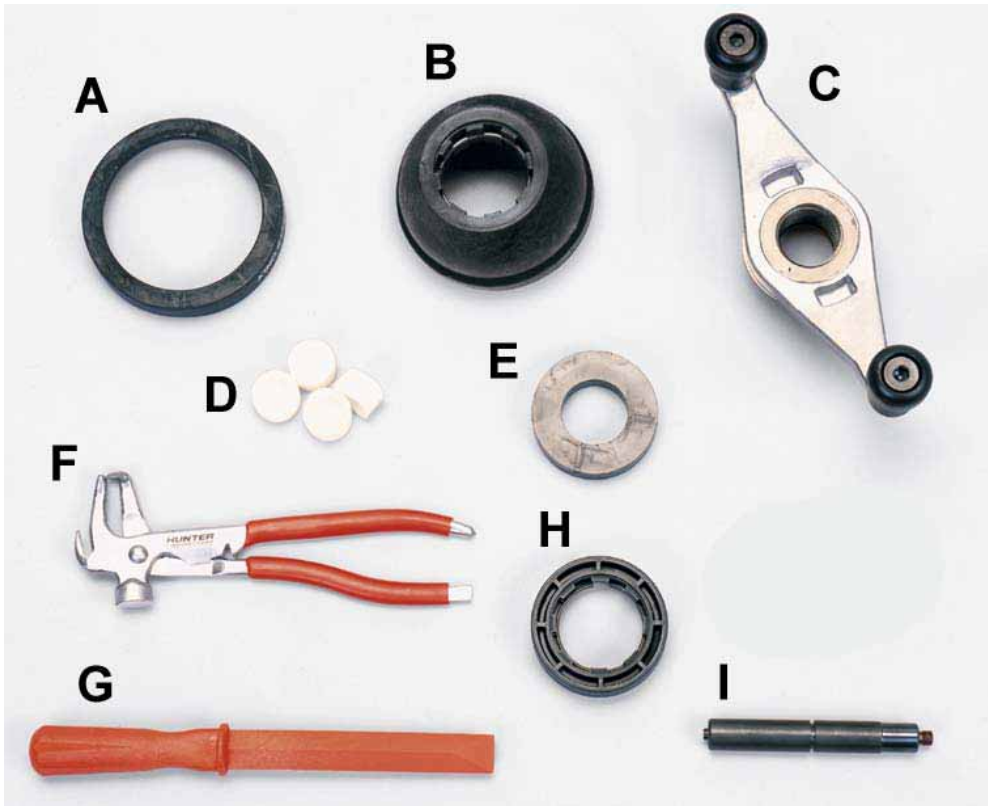

- | | | |
|----|-----------|-------------------------------------|
| 1. | 106-82-2 | Sleeve, Scratch Guard for Small Cup |
| 2. | 175-353-1 | Polymer Cup (4.5" O.D.) |
| 3. | 76-433-3 | Quick Take-Up Wing Nut with Handles |
| 4. | 221-658-2 | Hammer Heads (4) |
| 5. | 46-320-2 | Spacer |
| 6. | 221-589-2 | Weight Hammer/Pliers |
| 7. | 221-659-2 | Adhesive Weight Scraper |
| 8. | 223-68-1 | Pressure Ring |
| 9. | 65-72-2 | Calibration Weight |

NOTE: Hunter wheel balancers do not include a standardized set of mounting adaptors.

For optional accessories, refer to *Wheel Balancer Brochure, Form 3203T*.

1.4 Operating the Control Panel

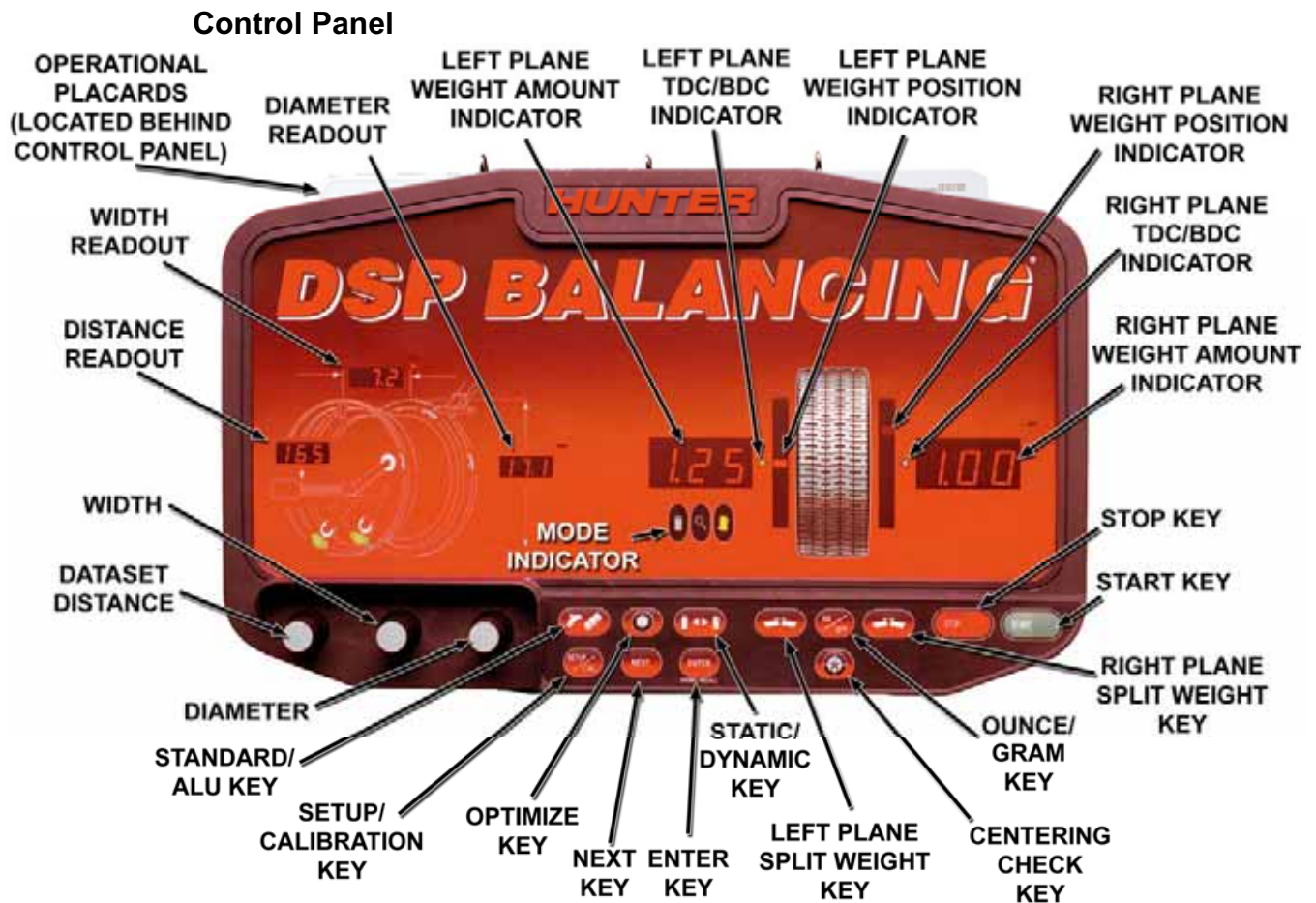



Using the Control Panel

Press the  "Standard/ALU" button to select a STANDARD or ALU procedure. Refer to "Standard Balancing Procedure (Using Clip-on Weights)," page 19 or "Adhesive Weight Procedures (Combination Of Clip-on & Adhesive Weights, or Two Adhesive)," page 36.

Press the  "Optimize" button to select an Optimize procedure. Refer to "OPT-1 Optimizing Tire & Wheel Imbalances (Wheel with the Tire Mounted Procedure)," page 42 or "OPT-2 Optimizing Tire & Wheel Imbalances (Tire Not Mounted Procedure)," page 43.

Press the  "Static/Dynamic" button to select the balancing mode. Refer to "Static / Standard Balancing Procedure (Clip-on Weight)," page 35 or "Static / ALU Balancing Procedure (Adhesive Weight)," page 41.

Press the  "Setup/Cal" button to select from the Setup or Calibration options. Refer to "Calibration Procedures," page 58.

Press the  "Next" button to change planes (green "weight" will indicate current plane selected) or scroll through menus, or to select wheel to store/recall.

Press the  "Enter" button to enter information and to begin a procedure that has been selected, or to "Store/Recall" wheels. Refer to "Storing and Recalling Wheels," page 55.

Press the  “Left Plane Split Weight[®]” button to split weights on the Left Plane. Refer to “Split Weight[®] Feature,” page 51.

Press the  “Oz/Gm” button to view balancing weights in ounces or grams.

Press the  “Right Plane Split Weight[®]” button to split weights on the Right Plane. Refer to “Split Weight[®] Feature,” page 51.

Press the  “CenteringCheck[®]” button to check the accuracy of the mounting of the tire/wheel assembly on the balancer shaft. Refer to “CenteringCheck[®],” page 25.

Using Wheel Dimension Control Knobs

The control knobs are located to the left of the control panel. The control knobs are used to manually input wheel dimension data. The control knobs are identified as the distance, width, and diameter control knobs.



Wheel dimension control knobs are used for manual data entry when required. Changes to wheel dimensions are made by rotating the knobs. The control knobs are digital encoder design and variable speed. Rotating slowly will change increments in single digits. Rotating quickly will advance and move increments at an increased rate.

2. BALANCING OVERVIEW

2.1 Balancing Modes

Static Balance

As the word static implies, the tire will be balanced when at rest. For example, if an unmoving assembly was centered on a cone and was balanced, it would be statically balanced. A “bubble balancer” is designed to statically balance a tire/wheel assembly.

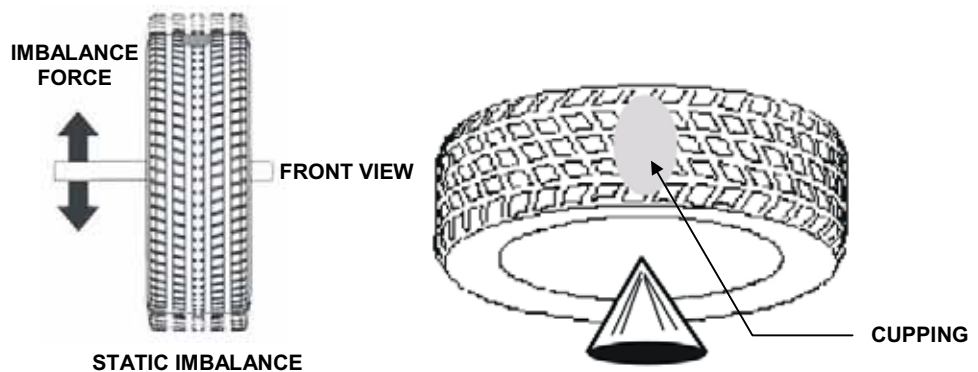

Static imbalance is where there is one amount of weight located in the center of the tire/wheel assembly causing an imbalance. As the weight rotates, centrifugal forces are created causing the wheel to lift as the weight reaches top dead center. This lifting motion causes the tire/wheel assembly to move “up and down” creating a bounce to be felt. This static imbalance condition is evident by a “jiggle” or up-down movement of the steering wheel. These vibrations may also be apparent in the body, with or without steering wheel shake.

A statically imbalanced tire driven for an extended period may cause “cupping” in the tire’s tread, create vibration, and adversely effect handling.

Static balancing alone is a seldom-recommended procedure that balances the assembly using only a single weight plane. For example, a single weight is commonly placed on the inner clip weight position for cosmetic purposes. This is not a recommended practice and usually insures the assembly is not properly dynamically balanced. The assembly may then experience side-to-side imbalance while in motion, causing a shimmy condition and objectionable vibration.

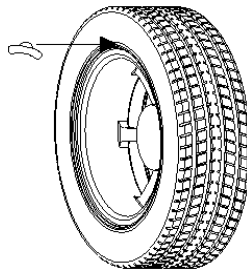

Dynamic Imbalance

In general terms, dynamic imbalance is defined as where one or more locations of the tire/wheel assembly are heavier causing an imbalance force and/or an imbalance wobble. Shown below is a tire/wheel assembly with two heavy spots of equal weight which are located 180 degrees radially from each other on opposite sides. As this assembly rotates, centrifugal forces cause a large imbalance wobble to be created, but the imbalance force (as well as the static imbalance) will be zero. A wheel with this condition will cause a wobble or shimmy to be felt in the steering wheel. Excessive dynamic imbalance of this type creates a shimmy that transfers through the suspension components to the occupants of the vehicle, especially at higher speeds.

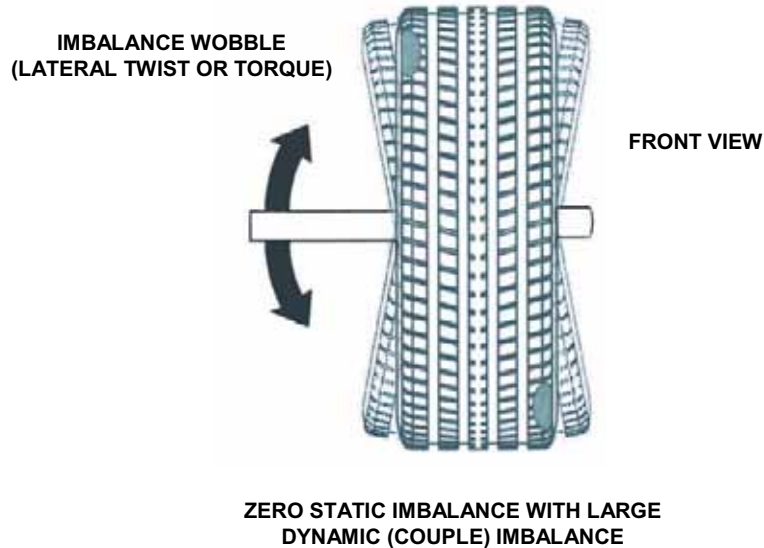

Modern “dynamic” balancers spin the wheel in order to measure both the up and down imbalance force and the wobble or shimmy related imbalance (side-to-side). Dynamic balancers direct the operator to place correction weights on the inside and outside correction locations of the rim so that both imbalance force and imbalance wobble will be eliminated.

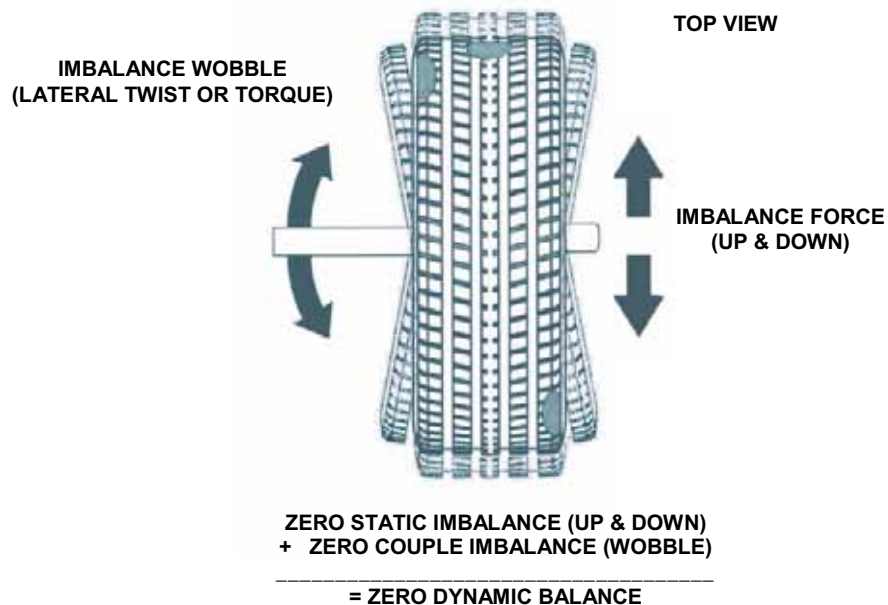

Static and Dynamic Imbalance Sensitivity

As a general rule of thumb, to achieve the best balance on an average sized tire and wheel assembly:

Residual static imbalance should be less than 1/2 ounce.

Residual dynamic imbalance should be less than 1/4 ounce per plane.

A small amount of residual dynamic imbalance is preferred over a similar amount of remaining static imbalance.

In general, it takes much more residual dynamic imbalance to cause a vibration than the same amount of static imbalance.

The larger the diameter used for weight placement, the smaller the amount of correction weight is required.

The wider the distance between the two weight placement locations, the smaller the amount of correction weight is required.

If static balance is the only option, always verify that the remaining dynamic residual imbalance is within acceptable tolerance.

2.2 Identifying the Static Balance Weight Plane

In "STANDARD BALANCE" mode, using only a clip-on weight, the plane is input as follows:

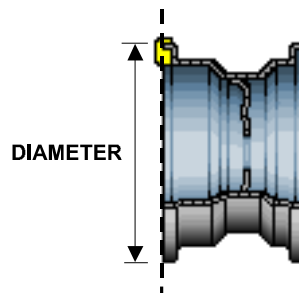

For static balancing, it is recommended that you place half of the correctional weight value on each side of the tire to reduce residual dynamic imbalance.

In "MIXED WEIGHTS BALANCE" mode and "ADHESIVE WEIGHTS BALANCE" mode, using an adhesive weight, the plane is input as follows:

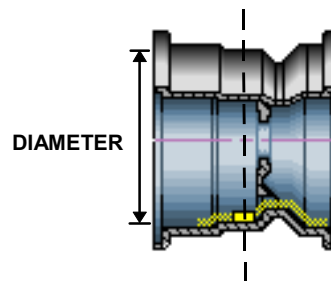

For static balancing, it is recommended that the adhesive weight be placed as close to the center of the wheel as possible to reduce residual dynamic imbalance.

In "PATCH BALANCE" mode, using a patch weight, the plane is input as follows:

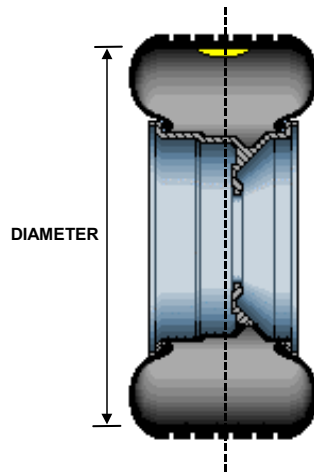

For static balancing, it is recommended that the patch weight be placed as close to the center of the tread as possible to reduce residual dynamic imbalance.

2.3 Identifying the Dynamic Balance Weight Planes

The balancer must know the location of the two weight circle planes for placement of correction weights on the wheel assembly.

Each plane is described by a distance from the balancer and a diameter.

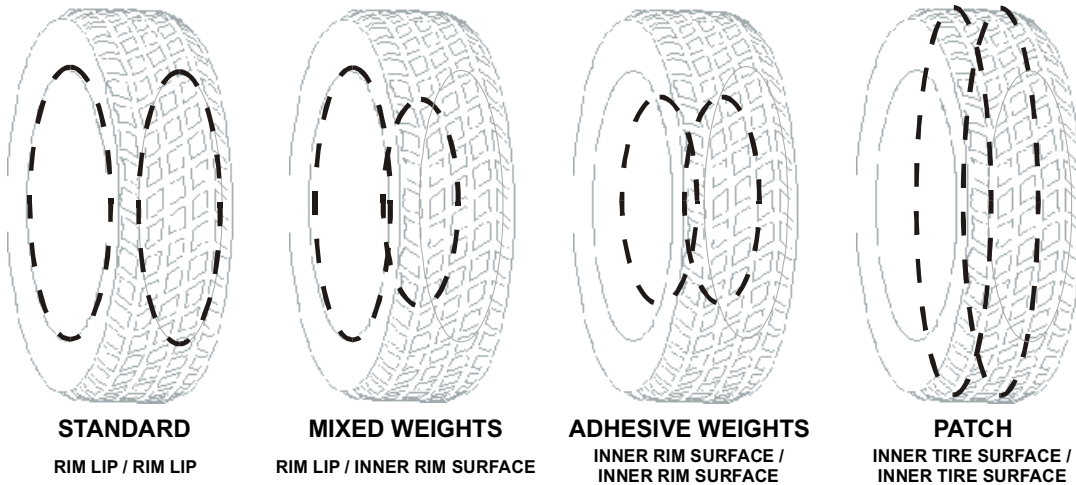

In "STANDARD BALANCE" mode, using only clip-on weights, left and right planes are input as follows:

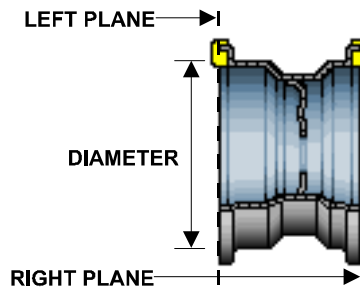

In "MIXED WEIGHTS BALANCE" mode, using clip-on and adhesive weights, the left and right planes are input as follows:

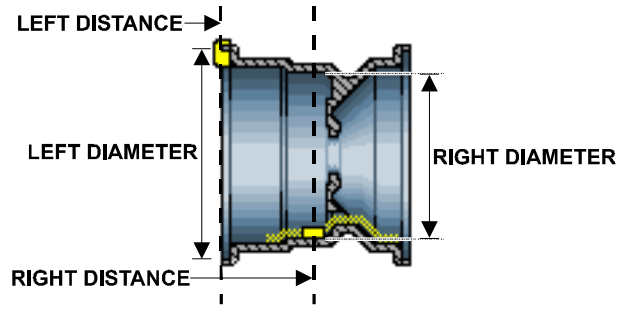

In "ADHESIVE WEIGHTS BALANCE" mode, left and right planes are input as follows:

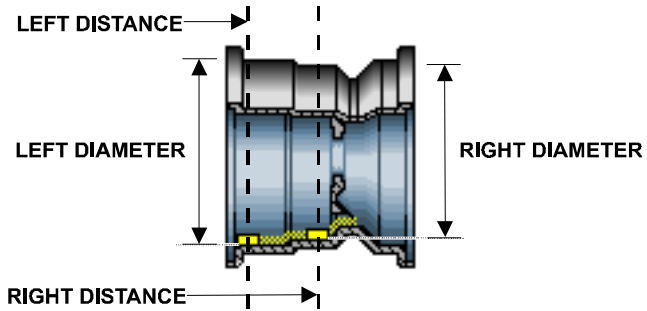

In "PATCH BALANCE" mode, using patch weights, left and right planes are input as follows:

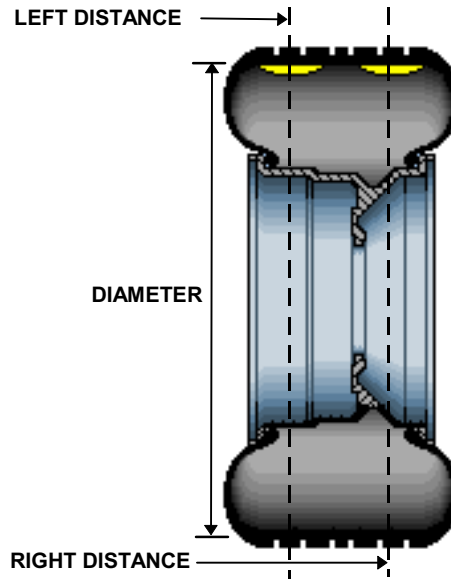

2.4 On-Vehicle Wheel Mounting Methods

Hub Centric

A hub centric wheel is aligned to the hub by the center bore of the wheel. The vehicle weight rests on the hub bore. The clearance between the hub bore and the hub on a hub centric wheel is between 0.003 and 0.004 of an inch. A hub centric wheel is identified by removing the lug nuts (or bolts) and moving the wheel up, down, and side-to-side. If there is little or no movement, the wheel is centered by the hub.

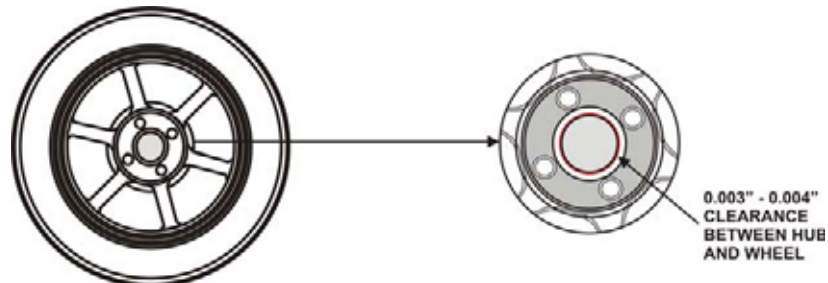

To verify if the wheel is hub centric:

Remove the lug nuts (or bolts) and try to move the wheel up/down and side/side on the hub.

If the wheel has no appreciable movement around or about the centerline of the hub, it should be considered hub centric.

A hub centric wheel will have very little (0.003 – 0.004") clearance or a slip fit to the hub.

Lug Centric

A lug centric wheel is identified by removing the lug nuts (or bolts) and moving the wheel up, down, and side-to-side. If movement around the hub is apparent, the wheel is centered on the vehicle by the lugs or studs of the axle flange.

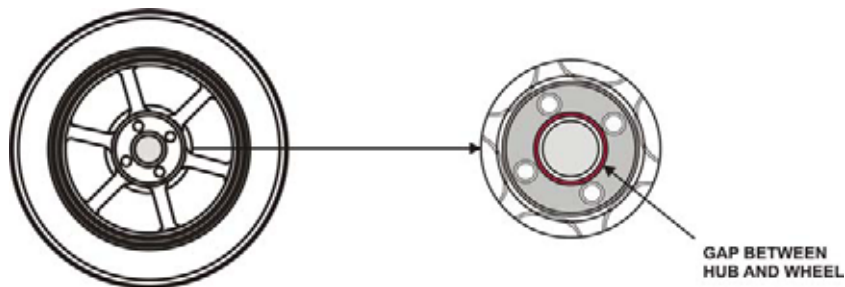

TIP:

When mounting a lug centric wheel to a vehicle, extreme centering care must be taken by ensuring the lug nuts (bolts) are tightened equally, while rotating the wheel.

“Step-torque” star pattern to proper torque specification.

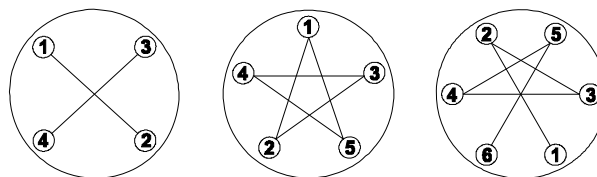

To verify if the wheel is lug centric:

Remove the lug nuts (or bolts) and try to move the wheel up/down and side/side on the hub.

A lug centric wheel will display noticeable movement.

3. BALANCING A WHEEL

3.1 Mount the Wheel on the Spindle Shaft

Remove any existing wheel weights, rocks, and debris from the tire tread, and clean the center hole of the wheel. Inspect inside of wheel for excessive accumulation of dirt and debris. Remove if necessary before balancing.

Accurate balancing depends on accurately centering the wheel. Choose the proper wheel mounting cone by placing it in the center hole of the wheel to be balanced. Refer to “CenteringCheck[®],” page 25.



NOTE:

If the basic cone and adaptors do not fit the wheel, additional centering adaptors will be necessary. A wheel that cannot be properly centered, cannot be properly balanced. All balancers require additional centering adaptors to properly center certain types of wheels. For additional information, refer to Form 3203T for optional accessories.

With the safety hood open, place the wheel mounting cone on the spindle shaft against the captivated spring. Position the wheel with the inside surface facing the balancer, centered on the cone.

Install the plastic clamping cup and wing nut on the spindle shaft against the wheel and secure the entire assembly by firmly tightening the wing nut.

If equipped with optional Spindle-Lok[®] foot pedal, depress and hold down while tightening the wing nut. Holding the shaft locked while tightening the wing nut improves centering accuracy.

Slowly roll the wheel towards you while tightening the wing nut. This improves accurate wheel centering, since the wheel is allowed to roll up the taper of the cone as opposed to forcing it to slide up the cone.

Front/Back Cone Mounting

Cone mounting is one of the most common and reliable ways to mount wheels on balancers.

Select the proper wheel mounting cone by placing it in the center bore of the wheel to be balanced. Select the cone that contacts the wheel nearest the center of the cone.

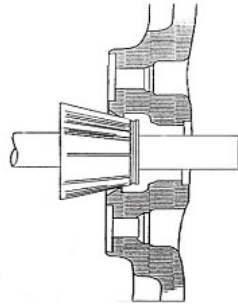

Place the wheel mounting cone on the spindle against the spring plate. Mount the wheel with the inner rim facing the balancer and centered on the cone.

Install the clamping cup and wing nut on the spindle shaft against the wheel and secure the entire assembly by firmly tightening the wing nut, while depressing the foot pedal to hold the spindle in place.

NOTE:

If equipped with optional Spindle-Lok[®] foot pedal, depress and hold down while tightening the wing nut. Holding the shaft locked while tightening the wing nut improves centering accuracy.

Slowly roll the wheel toward you during the initial tightening of the wing nut. This aids in accurate wheel centering and increased repeatability, since the wheel is allowed to roll up the taper of the cone as opposed to forcing it to slide up the cone.

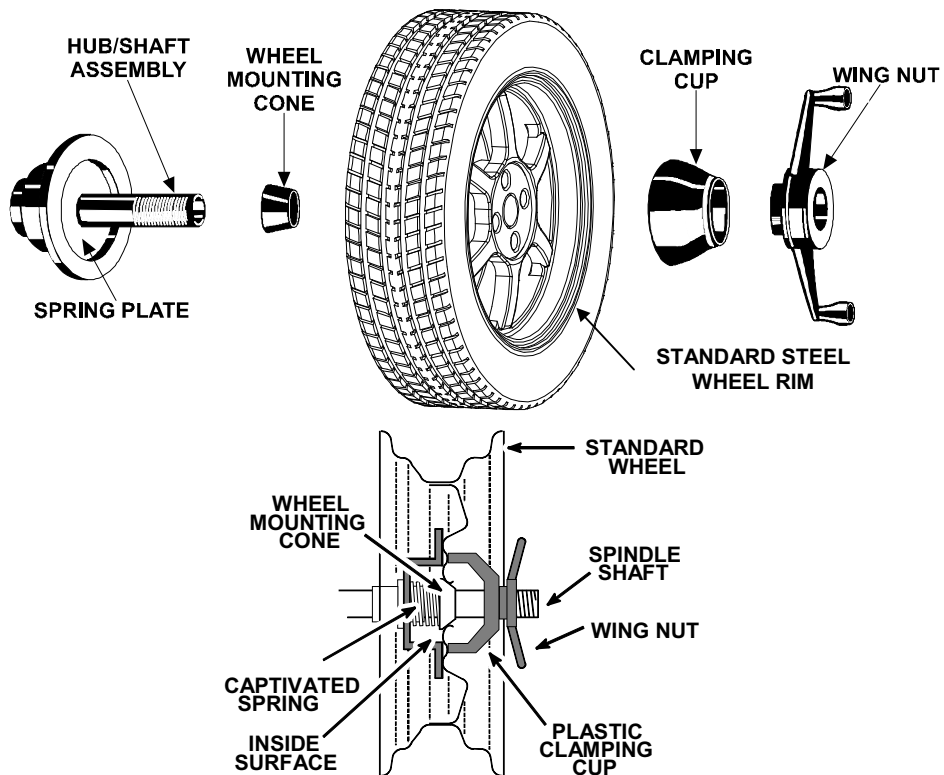

Wheels with center holes over 3 9/16 inch diameter require the light truck cone. The light truck cone can be installed from the outside of the wheel. (When using the light truck cone, the plastic clamping cup is not used.)

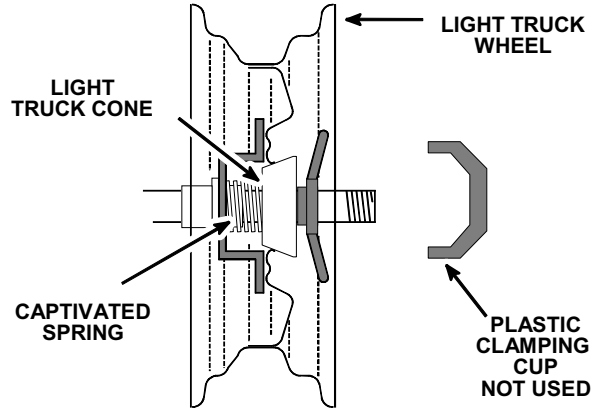

Using Plastic Wheel Mounting Washer

The plastic wheel mounting washer, 46-320-2, is used to prevent scratches on wheels where the standard plastic cup and scratch guard cannot be used.

The plastic wheel mounting washer can also be used when mounting a wheel with a large offset that is between cone sizes. Use of the washer as shown below can improve centering ability by increasing cone pressure against the wheel.

For example: One cone size is too small because the captivated spring is not pressing the cone against the inner wheel opening, but the next larger cone size is too big and will not fit the opening. Use the smaller cone size with the plastic wheel mounting washer to “extend” the captivated spring to hold the mounting cone against the wheel opening with greater pressure.

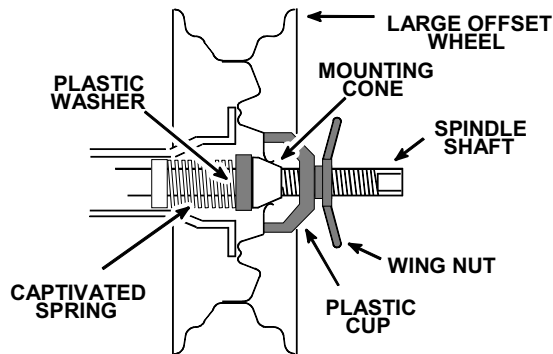

The scratch guard may be installed on the clamping cup to protect aluminum rims from being marred, but should not be used on steel wheels.

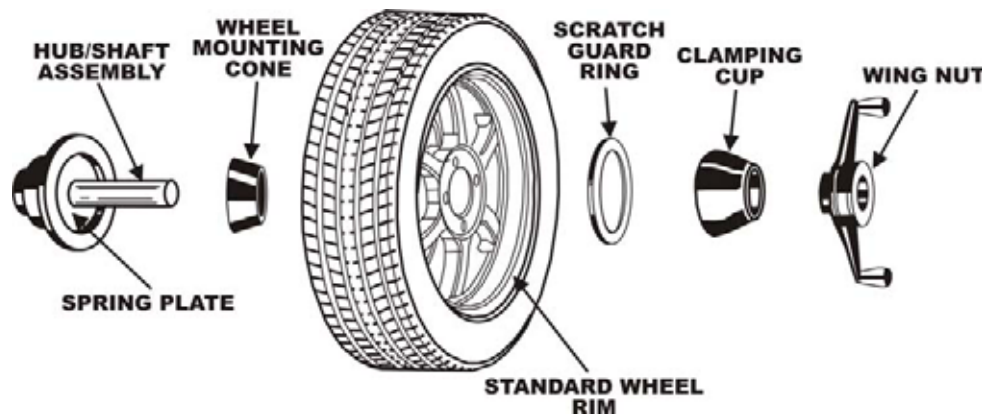

NOTE: Use only the wing nut supplied with the DSP9200.

In some cases, the mounting pad of the wheel may be extremely wide, and the standard clamp cup will not properly contact the wheel hub area. In these cases, the optional nine inch alloy wheel pressure cup may be used in place of the clamping cup.

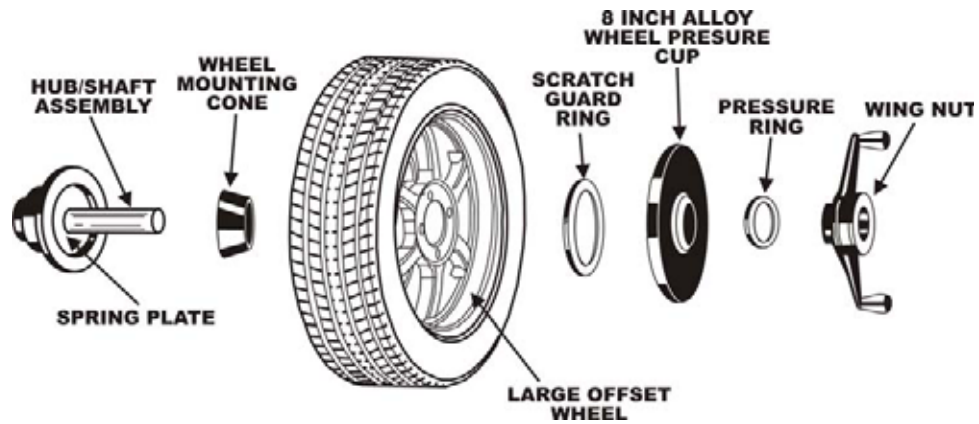

Wheels with center bores over 3 9/16 inch diameter require one of the light truck cones. The light truck cones must be mounted from the outside of the wheel.

NOTE: When using the light truck cones, the pressure ring is used in place of the clamping cup.

This procedure utilizes a tapered cone inserted from the front side of the wheel instead of the backside as previously described.

Select the proper wheel mounting cone by placing it in the center bore of the wheel to be balanced. Choose the cone that contacts the wheel nearest the center of the cone.

Mount the wheel with the inner rim facing the balancer. Place the wheel mounting cone on the spindle with the small end of the cone facing the front of the wheel.

Install the wing nut and pressure ring assembly onto the spindle shaft against the wheel and secure the entire assembly by firmly tightening the wing nut.

Heavy wheel centering may benefit by (1) pulling the tire away from the hub face at top dead center while tightening the wing nut or (2) use of optional wheel lift to position heavy wheel onto shaft and cone. This helps the wheel to overcome gravity against the hub or spacer.

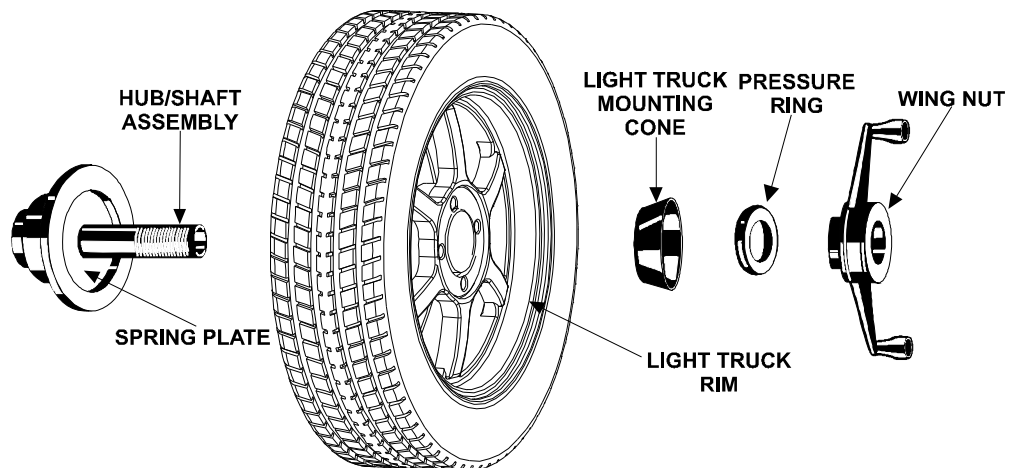

Cone/Flange Plate Mounting

Wheels may be centered using the lugholes and center bore with a flange plate and centering cone. It is important that a back mounted cone be used to support and center the wheel when using flange plates.

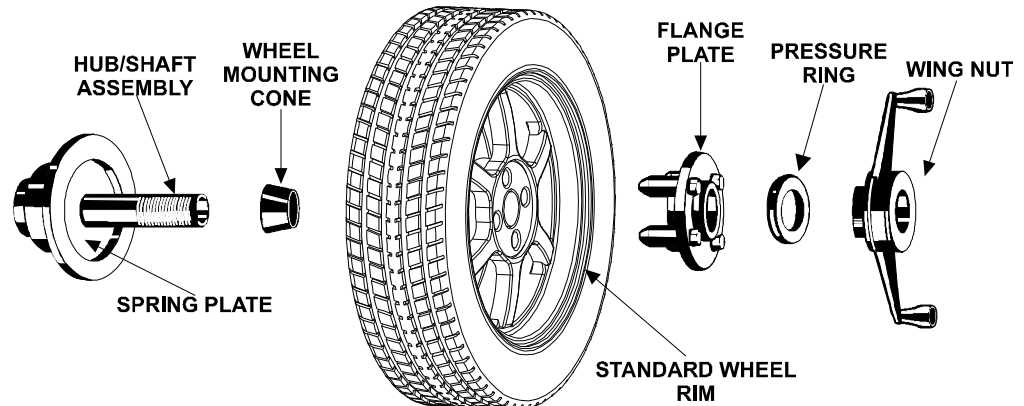

The correct flange adaptor setup is determined by:

1. Measure and set the bolt circle diameter and number of studs to use against the lug holes.

Set the number of lugholes as follows:

A three-lug wheel uses three studs.

A four-lug wheel uses four studs.

A five-lug wheel uses five studs.

A six-lug wheel uses three studs.

A seven-lug wheel uses seven studs.

An eight-lug wheel uses four studs.

2. Choose the correct taper design of flange studs to fit the wheel lug seats. The mounting area of the flange stud must match the design of the wheel's lughole seat or depression.

The flange plate must be able to apply pressure to the center of the wheel while maintaining perpendicularity to the shaft.

NOTE:

If the lug seats are unevenly machined or worn, an optional universal flange adaptor with compressible studs or bolt on lugs may be used to more accurately mount the wheel with the cone.

Flange plates are useful when the wheel cannot be properly centered off the hub bore with a tapered cone alone because of improper fit, interference, or lack of a center hole.

A flange plate in many cases adds value because it aids in more effective centering than a tapered cone alone. This statement is true for many wheels including hub centric wheels. That is why a flange plate and back cone may be more accurate and repeatable, regardless of whether the wheel is lug centric or hub centric.

Using the Pressure Ring and Spacers

Pressure Ring

The pressure ring clips on to the wing nut. It is used in lieu of the clamping cup.

It may also be used in place of a clamping cup if space is limited between the wheel and the end of the spindle.

The pressure ring should be used to prevent the wing nut from directly contacting an adaptor or a cone. It will act as a bearing to enable higher clamping forces.

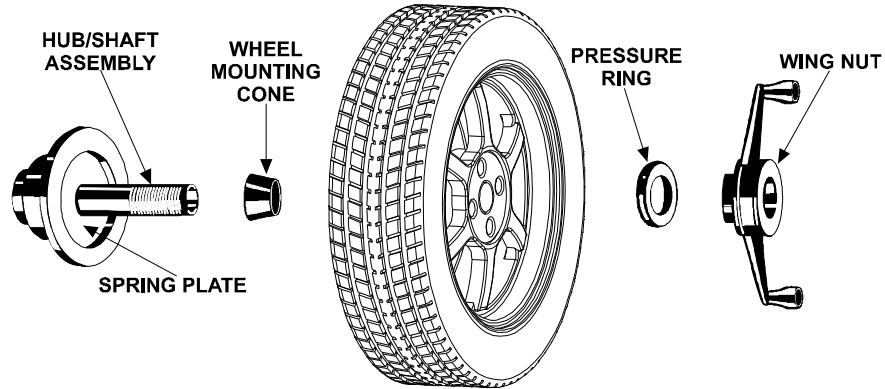

Spacers

There are two types of spacers:

- Hub Ring Spacers
- Shaft Spacers

Hub Ring Spacers

These light truck spacers are designed to build a larger pocket when using extra large truck cones. It also provides a location for the centering pins found on some dual wheel configurations.

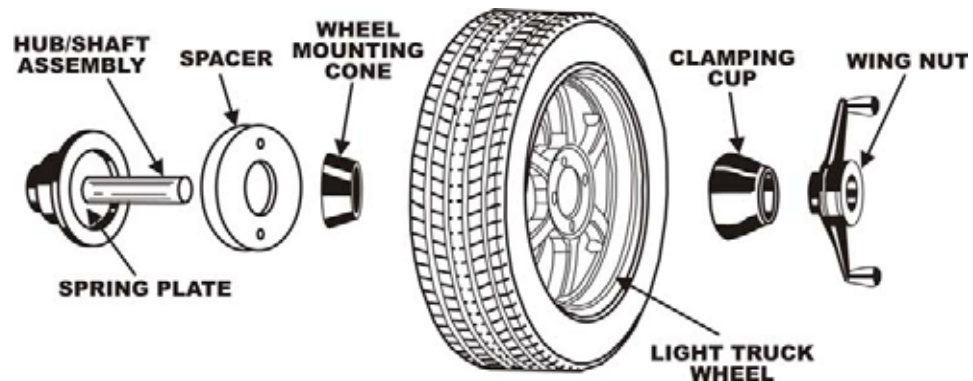

Shaft Spacers

The shaft spacer can be used to make the cone contact the hub bore more firmly.

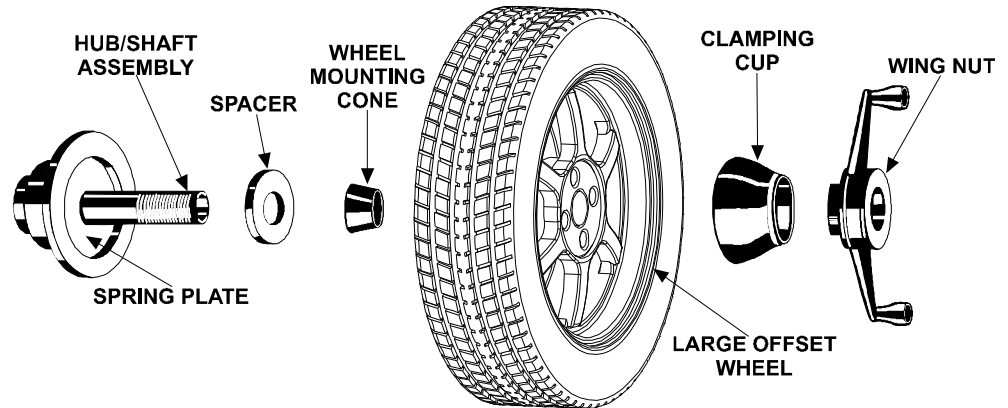



For example, one cone size is too small because the captivated spring is not pressing the cone against the inner wheel opening, but the next larger cone size is too large and will not fit the opening. Use the smaller cone size, with the spacer, to extend the captivated spring and hold the smaller mounting cone against the wheel opening with greater pressure.

CenteringCheck®



After mounting the wheel on the spindle and securing with the wing nut, press the  “CenteringCheck®” button.

Display shows “Rdy” “Spn.”

Press  “Start” or lower hood to spin. When spin ends, display shows “Put” “Top,” and valve stem flashes.

Rotate wheel until valve stem is at TDC and press  “Enter” or step on foot pedal. Display shows “rot” “180.”

Step on foot pedal to lock spindle. Loosen wing nut and rotate wheel and adaptors about 180 degrees. Tighten wing nut. (Press  “Enter” if no foot pedal.) Display shows “Rdy” “Spn.”

Press  “Start” or lower hood. When spin ends, rotate wheel until valve stem is at TDC, and press  “Enter” or step on foot pedal.

If centering of the assembly repeats balance weight magnitude and phase angle to within programmed limits, the assembly is assumed to be centered. The display momentarily flashes “PASS,” then shows correction weights.

If centering of the assembly does not repeat balance weight magnitude and phase angle to within programmed limits, the assembly is likely not centered. The display momentarily flashes “FAIL” then shows “---” instead of weights. Check wheel to adaptor fitment and centering. Retry.

3.2 Measuring the Wheel with Inner and Outer Auto Dataset® Arms

Auto Dataset® is a faster and more accurate method to take rim measurements than traditional manual wheel data entry methods. Auto Dataset® is used to input rim distance, rim width, and weight plane location automatically. The Dataset® arms of the DSP9200 are positioned at the weight plane and data is entered by depressing the foot pedal.

Measuring Dimensions for Clip-On Weights:

Lift or pull the inner Dataset® arm away from the weight tray to trigger a new left plane reading. A beep will occur and the green LED left rim lip “weight” will blink to prompt for the input of the left plane weight. When the arm is steady, step on the foot pedal, a confirmation beep occurs, the inner distance and rim diameter readouts are updated, and the prompt stops blinking.

Lift or push the outer Dataset® arm toward the weight tray to trigger a new right plane reading. A beep will occur and the green LED right rim lip “weight” will blink to prompt for the input of the right plane weight. When the arm is steady, step on the foot pedal, a confirmation beep occurs, the wheel width readout updates and the prompt stops blinking.

TIPS:

1. Both Dataset® arms may be used simultaneously.



2. If the balancer determines that the weight planes are too close together, the weight digits will be turned off and the distance and the width digits will start blinking. Re-enter the planes to correct this condition.
3. If the Dataset® arm is not steady when the foot pedal is depressed, there will be a long error beep.
4. If the Dataset® arm is returned to the storage position before a reading is taken, the trigger is canceled and the prompt stops blinking.
5. After taking a reading, the Dataset® arm must be returned to the storage position to trigger a new reading.
6. If STATIC mode is in effect, distance readouts will not be updated. Distance readouts are not used in STATIC mode.

NOTE:

The wheel diameter input by the inner auto Dataset® arm might be slightly different from the known nominal wheel (tire bead seat) diameter. The auto Dataset® arm measures the actual weight circle instead for the rim lip configuration of the wheel. A more accurate wheel balance will result if the reading is not manually (knob) adjusted to the nominal wheel diameter.

Mixed Weights and Two Adhesive Weights (Inputting Distance and Diameter for Both Planes):

The inner Dataset[®] arm will trigger as it is raised from the home resting position (left plane green LED “weight” will blink as a prompt). Place the pointer tip or pointer disc edge at the desired left plane weight location, and step on the foot pedal. The reading will be taken and the display will update the left plane weight position.

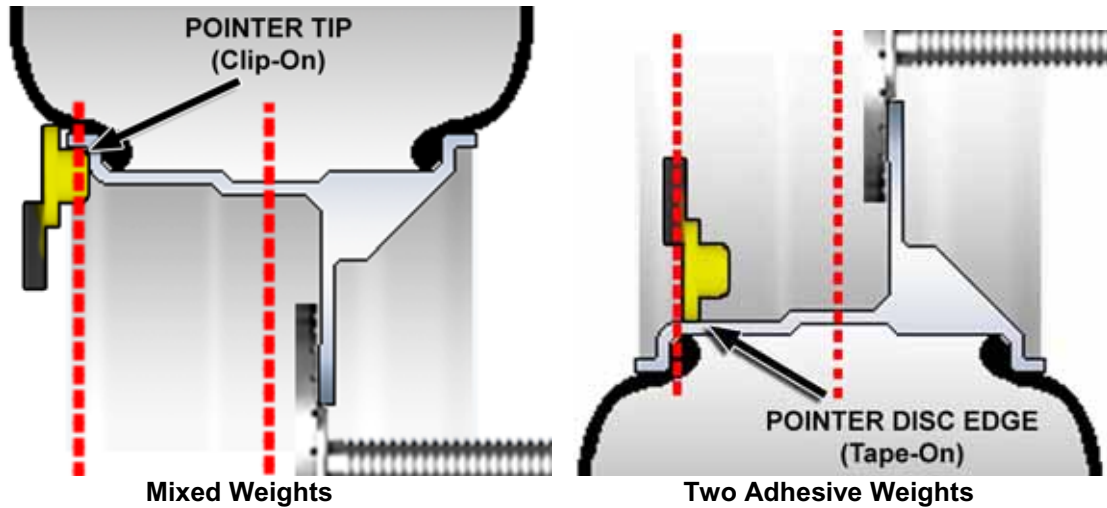

Right plane green LED will now blink as a prompt for the right plane weight to be input.

Before returning the inner Dataset[®] arm to the storage position, place the disc edge at the desired right plane weight location and step on the foot pedal. The weight position will be taken and the display will automatically change to show the right weight LED and the new right plane weight dimensions.

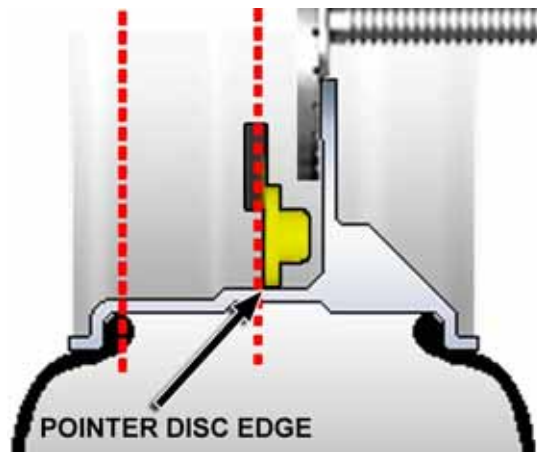

A confirmation beep occurs, the readouts change to the newly acquired values and the prompt stops flashing.

The dimension digits will now blink a prompt for optional “Split Spoke[®]” mode. Refer to “Split Spoke[®] Feature,” page 53, or return the arm to the home position.

3.3 Manually Setting Wheel Dimensions



The distance knob (1) is used to input the distance from the balancer to a weight plane.

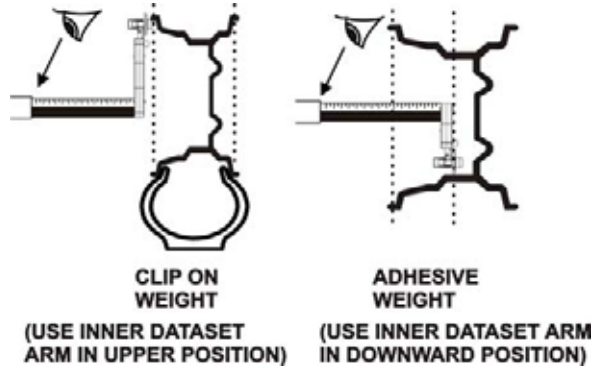

The width knob (2) is used to input the distance from the left weight plane to the right weight plane.

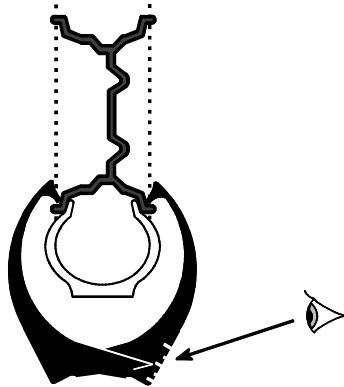

The diameter knob (3) is used to input the weight circle diameter of a weight plane.

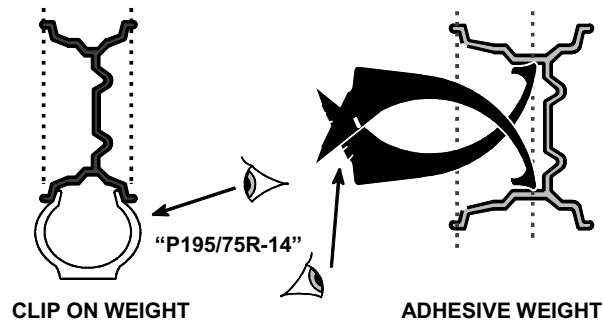

The optional inner auto Dataset[®] arm can be used to automatically measure distance and diameter. Refer to "Measuring the Wheel with Inner and Outer Auto Dataset[®] Arm(s)," page 26.

The optional outer auto Dataset[®] arm can be used to automatically measure wheel width. Refer to "Measuring the Wheel with Inner and Outer Auto Dataset[®] Arm(s)," page 26.

Measuring the Wheel at the Inner Rim Lip (Clip-On Weight)

Measure the distance to the wheel inner rim lip by pulling the sliding Dataset[®] arm pointer outward until it is touching the wheel inner rim lip. Read the Dataset[®] arm scale and set the distance knob to the reference number on the scale.



Most of the time, the Dataset[®] arm pointer will contact the rim lip as shown in illustration (A) below. In some cases, the rim lip may be so wide that the pointer disk touches the rim as shown in illustration (B) below. In either case, the balancer will compensate for this and provide accurate weight locations.

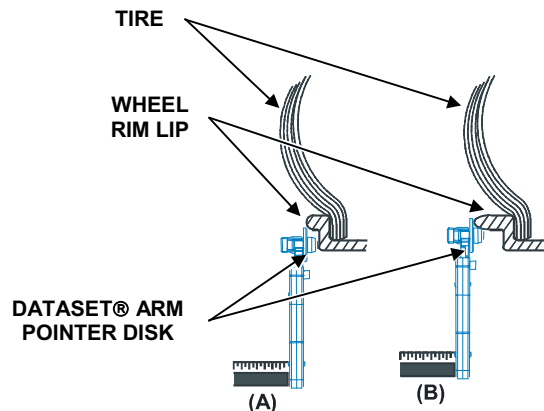

Measuring Wheel Width with Rim Width Calipers

The rim width calipers are used to measure the distance between the wheel rim lips (tire bead seats).

Apply the rim width calipers as shown below.

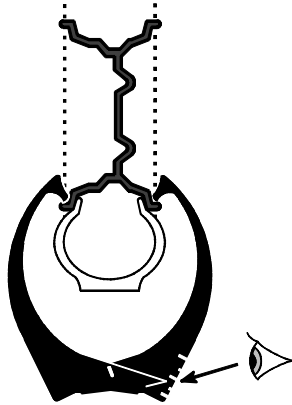

Read the scale imprinted on the rim width calipers and set the rim width knob to the rim width reference number on the scale.

Measuring the Inside Wheel Surface with the Pointer Disk Edge (Adhesive Tape-On Weights)

Place edge of manual Dataset[®] arm disk against the inside surface of the wheel at the location where the **right edge** of the adhesive weight is to be placed. Set Dataset[®] arm distance knob to the reference number on the Dataset[®] arm scale.

| | |
|--------------|---|
| NOTE: | The Dataset [®] arm is used in the position as shown in the photo below. |
|--------------|---|



TIP:

When using Adhesive Weight programs, the greater the distance between the two weights, the less weight it takes to perform a dynamic balance. The balancer prevents the operator from locating the two wheel weights too close together to provide a correct dynamic balance.

For example: The illustration below shows the installation of two adhesive weights. The weight locations are at the minimum allowed distance.

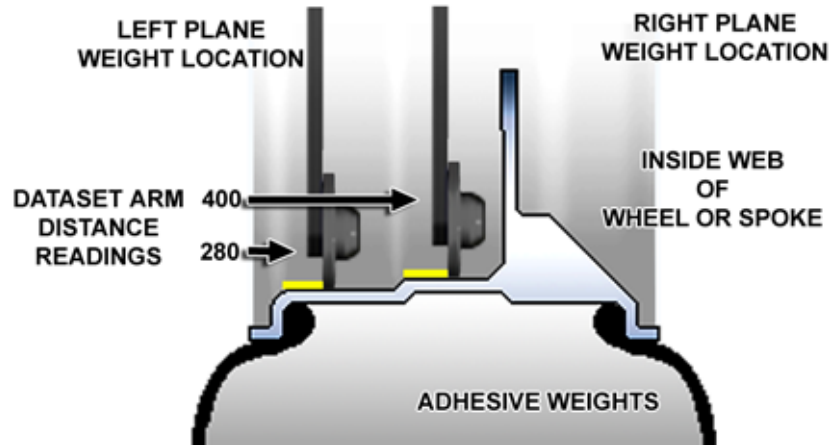

If the weight locations are moved any closer together using the Dataset[®] distance knob or auto Dataset[®] arm, the distance digits will blink and the weight amount display will change to - - - - -. Move either weight location away from the other weight location to resolve this situation before proceeding.

*An optimum chosen position by the operator would be at the extreme left edge of the wheel and extreme inside right edge (280 and 400 as shown). This would lessen the total amount of weight required in order to perform a correct dynamic balance.

Measuring the Inside Wheel Diameters (For Adhesive Weights)

If other wheels have been removed from the vehicle, it will be easier to measure inside rim diameters on an unmounted wheel. Use rim width calipers or a tape measure to make the measurements for both the plane right and left plane adhesive weight location internal wheel diameters as shown below.

Measure the rim inside diameters at the same location where the wheel weight is to be placed and set the wheel diameter knob to the measurement:

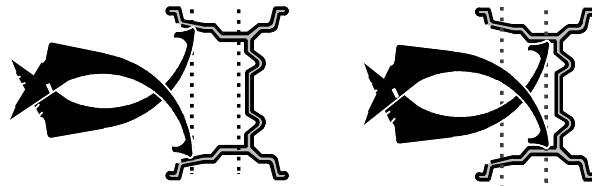

OR



3.4 Locating the Wheel Weights at the Top Dead Center (“TDC”) and Bottom Dead Center (“BDC”)

Clip-on weights are always located at TDC and adhesive tape-on weights are always located at BDC as shown on the weight indicator display.

Find TDC by turning the wheel until the Green Arrow and the Center LED on the weight indicator are both “ON” (see the left plane weight indicator in the illustration below). In this position, a balance weight has to be attached at top dead center. To automatically position weights at TDC or BDC, refer to “Motor Drive/Servo-Stop,” page 49.

To apply wheel balancing weights at TDC (12 o'clock position), align the weights with the white line on the spindle housing. The line is used to accurately locate the TDC position.

When the weight indicator LED bar is blinking, it indicates that the weight location is more than 90 degrees from TDC (on the hidden side of the wheel). When the green arrow is blinking, it indicates that the weight location is at BDC. The illustration below shows the wheel positioned at TDC for placement of the left plane weight, while the right plane weight position is 180 degrees from TDC (Bottom Dead Center - BDC).

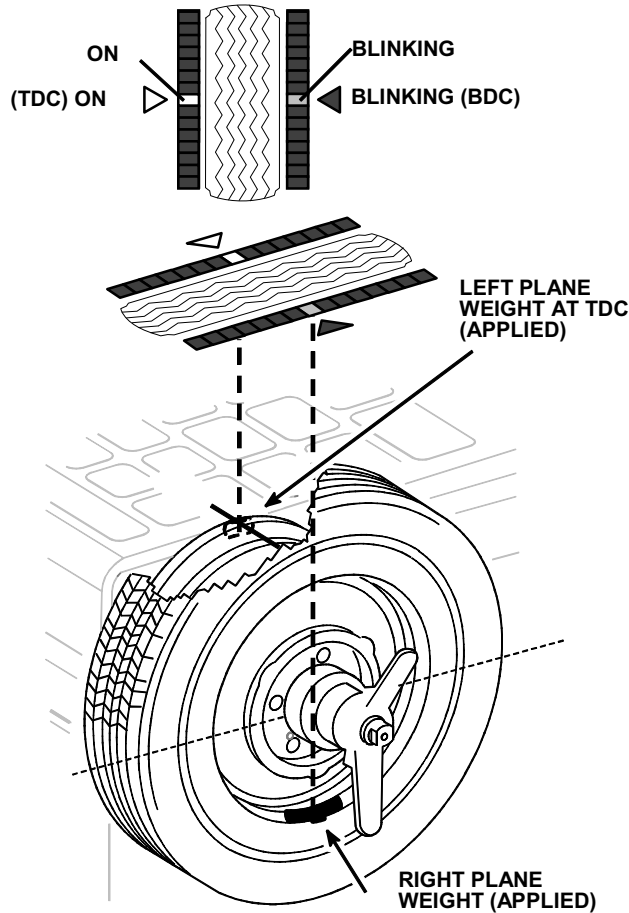

3.5 Standard Balancing Procedure (Clip-on Weights)

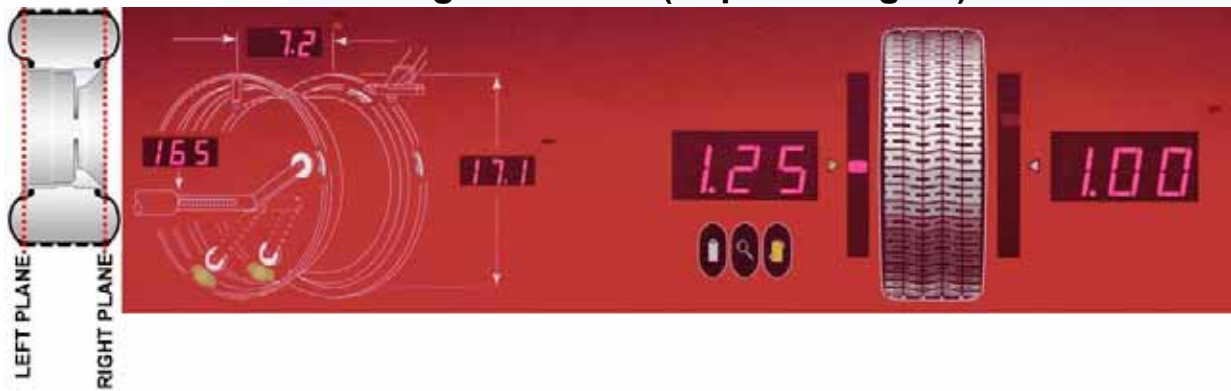

Mount wheel.

Press the  "Static/Dynamic" button to select DYNAMIC .

Press the  "Standard/ALU" button until both clip-on weights are blinking. Measure and enter the distance to the wheel inner rim lip and rim diameter as shown below:

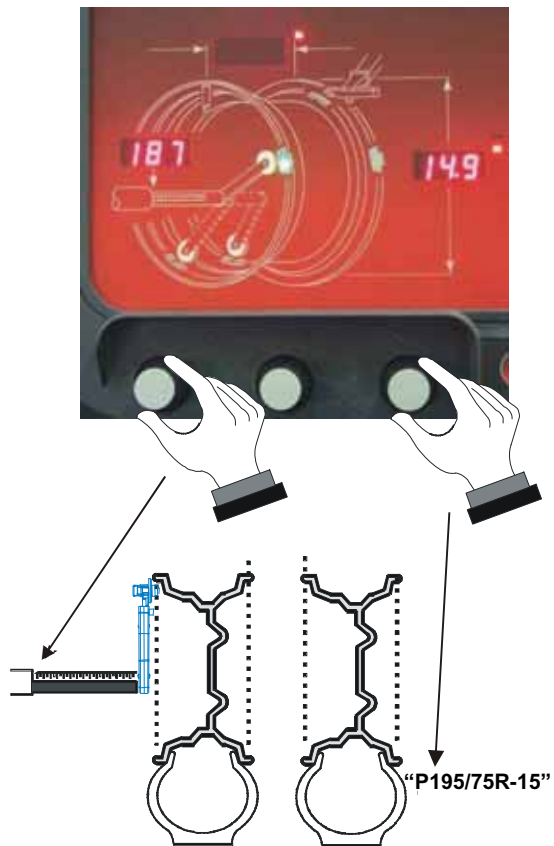

Measurement can be input automatically, if the DSP9200 is equipped with the optional auto inner and/or outer Dataset[®] arms.

Measure and enter the wheel width as shown below:

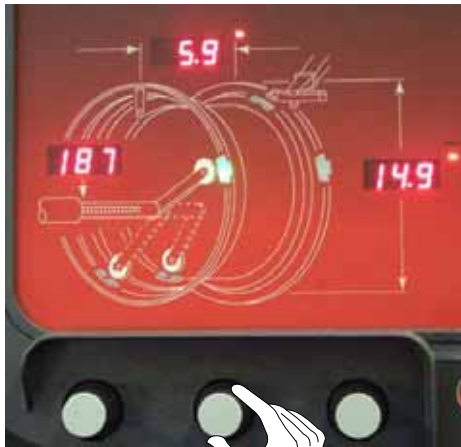

OR

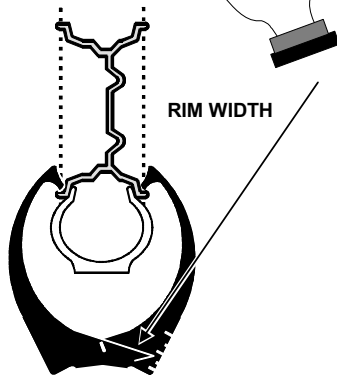



This measurement can be input automatically, if the DSP9200 is equipped with the optional auto inner and/or outer Dataset® arms. Refer to “Measuring the Wheel with Inner and Outer Auto Dataset® Arm(s),” page 26.

Close safety hood and spin wheel.

After wheel stops, raise safety hood.

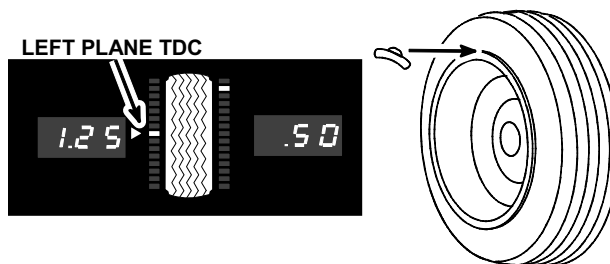
Find TDC for left plane and attach weight.



If necessary, use the  “Left Plane Split Weight®” button to split weight.

Find TDC for right plane and attach weight.

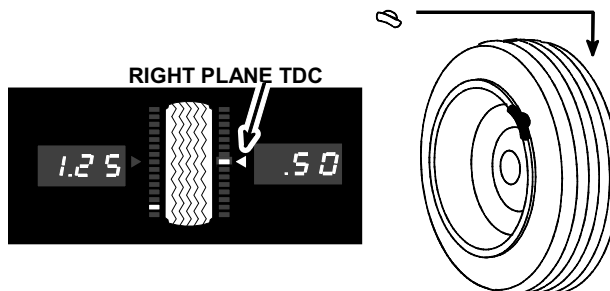

If necessary, use the  “Right Plane Split Weight®” button to split weight.

Verify balance condition by spinning again. Display should show “zero.”
“Standard” balancing procedure is complete.



NOTE: Weight digits blink if the force signals are larger than the measurement range of the balancer. If this occurs, check for wheel not being properly centered on spindle shaft. If wheel is centered, apply the displayed weights. The blinking weights indicate that a second spin and additional weight(s) may be required to get zero imbalance. Refer to “Correcting Large Imbalances,” page 52.

3.6 Static / Standard Balancing Procedure (Clip-on Weight)



Use STATIC / STANDARD balancing procedure for “static” (single-plane) balancing using a clip-on weight.

Mount wheel.

Press the  “Static/Dynamic” button to select STATIC .

Press the  “Standard/ALU” button until both clip-on weights are blinking.

Measure and enter the rim diameter of static plane weight location as shown below:

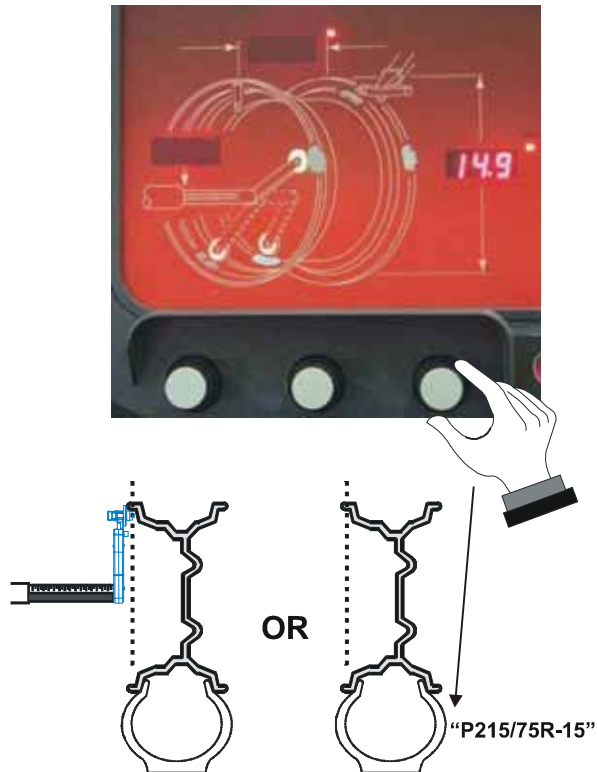

This measurement can be input automatically, if the DSP9200 is equipped with the optional auto inner and/or outer Dataset[®] arms.

Close safety hood and spin wheel.

After wheel stops, raise the safety hood.

Find TDC for static plane and attach clip-on weight on either rim lip.

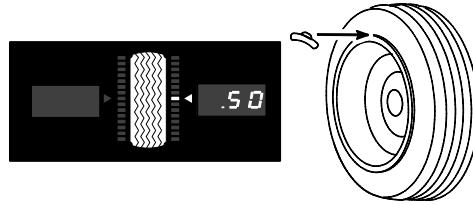

NOTE: It is recommended that the weight be distributed equally between the left and right rim lips to provide minimum residual dynamic imbalance.
For example: In the illustration above, place a 0.25 oz. weight amount on each rim lip at the TDC position.

If necessary, use the  “Right Plane Split Weight[®]” button to split weight. Verify balance condition by spinning again. Display should show “zero.” The STATIC / STANDARD balancing procedure is complete.

3.7 Adhesive Weight Procedures (Combination of Clip-on & Adhesive Weights, or Two Adhesive)

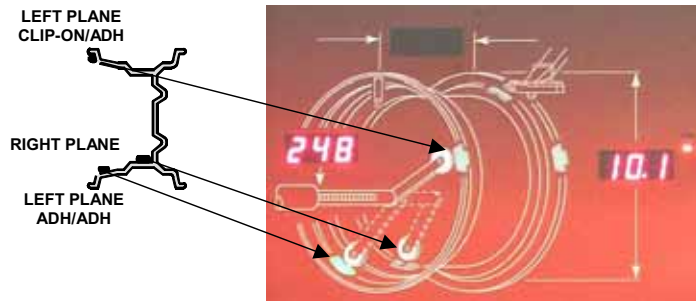

The following combinations of weight placements are available:

| Adhesive Weight Placement (Types and Locations) | |
|---|---|
| <i>Left Plane</i> | <i>Right Plane</i> |
| Dynamic Balancing | |
| Clip-On (TDC) | Adhesive inner (backside of wheel, BDC) |
| Clip-On (TDC) * | Adhesive outer (front side of wheel, BDC) |
| Adhesive (BDC) | Adhesive inner (backside of wheel, BDC) |
| Adhesive (BDC) * | Adhesive outer (front side of wheel, BDC) |
| Static Balancing | |
| N/A | Adhesive inner (backside of wheel, BDC) |
| * Select front side weight placement mode by entering either clip-on/adhesive or adhesive/adhesive mode, then move the optional outer Dataset [®] arm away from the home position. | |

Mount wheel.

Press the  “Standard/ALU” button repeatedly until the desired combination of weight placements are lit on the display.
Measure and enter the dimensions of the left plane weight location as shown below:



CLIP-ON/ADHESIVE

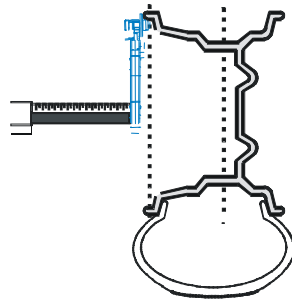

ADHESIVE/ADHESIVE

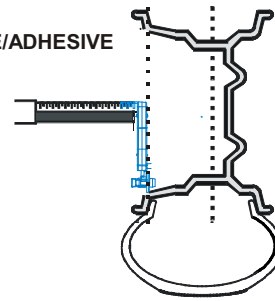

“P245/50ZR-15”

“P245/50ZR-15”

Press the  “Next” button to change display to show right plane weight dimensions.

Measure and enter the dimensions of right plane weight location as shown below:

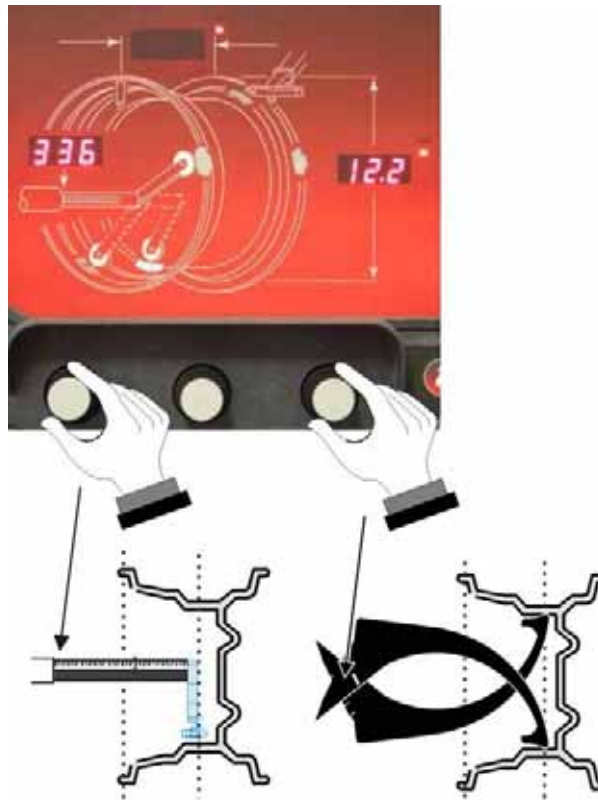

If using the optional inner Dataset[®] arm, refer to “Split Spoke Feature,” page 53. This measurement can be input automatically, if the DSP9200 is equipped with the optional auto inner and/or outer Dataset[®] arms. Refer to “Measure the Wheel with Inner and Outer Auto Dataset[®] Arm(s),” page 26.

Close safety hood and spin wheel.

After wheel stops, raise safety hood.

Find TDC for left plane and attach clip-on weight, or find BDC for left plane and attach adhesive weight.

CLIP-ON/ADHESIVE
LEFT PLANE TDC

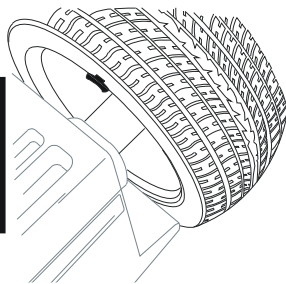
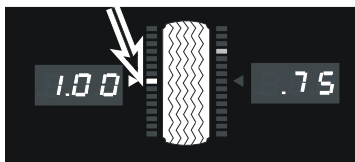

ADHESIVE/ADHESIVE
LEFT PLANE BDC
(BLINKING)

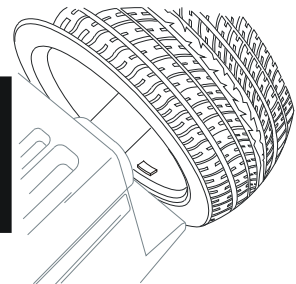
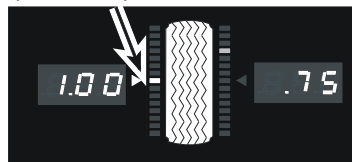

If necessary, use the  “Left Plane Split Weight[®]” to split weight.

The 360 degree weight angle display can be used to place the adhesive weight at Bottom Dead Center (BDC) for easier and more accurate placement than the conventional TDC method. If TDC placement is desired, press the  “Stop” button to disable Servo Stop. Rotate the wheel to TDC and attach weight.

The Dataset[®] arm may be used as a reference device for locating previously input placement position of adhesive weight on left or right plane. If equipped with an optional inner auto Dataset[®] arm, servo to locate an adhesive weight at BDC, then trigger the Dataset[®] arm to begin Servo Aided Weight Placement. Refer to “Servo Aided Weight Placement,” page 47.

If using a manual Dataset[®] arm, press the  "Next" button (if necessary) to change display to show distance to the weight plane (right or left) for the weight being placed.

Pull Dataset[®] arm out until the scale reading and the display right plane distance reading are the same.

Find BDC for right plane as shown below.

Attach adhesive weight at BDC in-line with the Dataset[®] arm disc edge, using Servo Aided Weight Placement or manual Dataset[®] arm as described above.

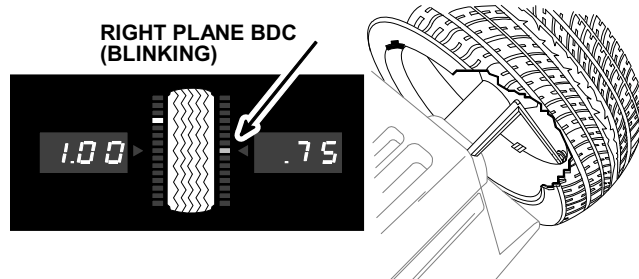

If necessary, use the  "Right Plane Split Weight[®]" to split weight.

Verify balance condition by spinning again. Display should show "zero."

Balancing procedure is complete.

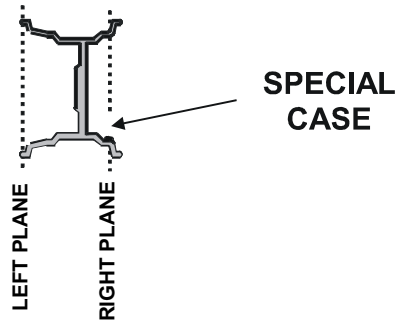

WHEN RIGHT WEIGHT IS TO BE PLACED AS ILLUSTRATED, INPUT RIGHT PLANE DIMENSIONS AS FOLLOWS:

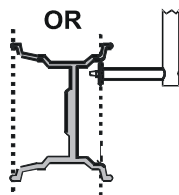
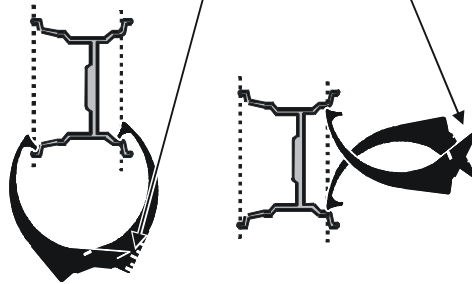
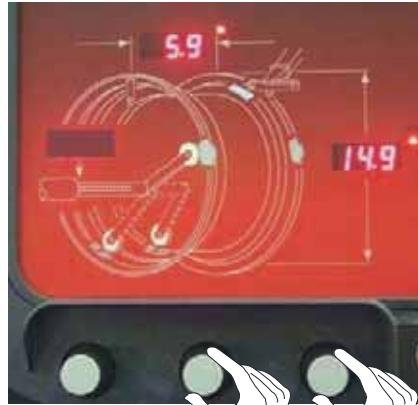



OUTER AUTO DATASET® ARM AUTOMATICALLY INPUTS DISTANCE TO OUTER WEIGHT (CALIPER MEASUREMENT NOT REQUIRED).

3.8 Static / ALU Balancing Procedure (Adhesive Weight)



Use STATIC / ALU procedure for “static” (single-plane) balancing using an adhesive weight. Because “static” balancing depends on the placement of only one weight, in this procedure only one adhesive weight is shown, not an additional clip-on or adhesive weight.

Mount wheel.

Press the  “Static/Dynamic” button to select STATIC .

Press the  “Standard/ALU” button to select one adhesive weight.

Measure and enter the internal diameter and distance near the center of wheel as shown below:

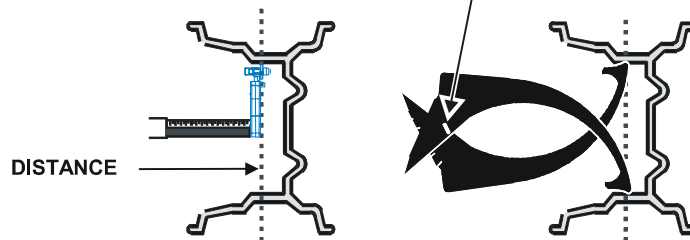

OR
INNER AUTO DATASET®
AUTOMATICALLY INPUTS
DISTANCE AND DIAMETER.

This measurement can be input automatically, if the DSP9200 is equipped with the optional auto inner and/or outer Dataset® arms.

If necessary, use the “Split Spoke” feature. Refer to “Split Spoke Feature,” page 53.

Close safety hood and spin wheel. After wheel stops, raise safety hood.

The 360 degree weight angle display can be used to place the adhesive weight at Bottom Dead Center (BDC) for easier and more accurate placement than the

conventional TDC method. If TDC placement is desired, press the  "Stop" button to disable servo and rotate the wheel to TDC and attach weight. Find BDC for static plane as shown below. Attach adhesive weight at BDC in-line with the Dataset[®] arm disc edge.

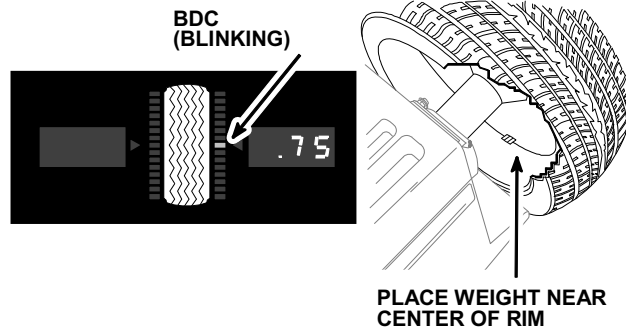

NOTE: It is recommended that the weight be attached near the center of the wheel to provide minimum residual dynamic imbalance.

If necessary, use the  "Right Plane Split Weight[®]" to split weight. Verify balance condition by spinning again. Display should show "zero." The STATIC / ALU balancing procedure is complete.

3.9 OPT-1 Optimizing Tire & Wheel Imbalances (Wheel with the Tire Mounted Procedure)



"Optimizing" positions the wheel with respect to the tire, minimizing the amount of correction weight required.

Use OPT-1 when the tire is already mounted on the wheel.

Mount the tire/wheel assembly on the spindle shaft with the valve stem at TDC.

Enter Standard wheel dimensions.

Press the  "Optimize" button once.

Press the  "Enter" button to begin procedure.

Display shows "Put" "Top," and the valve stem is flashing. Rotate the wheel until the valve stem is at TDC and press "Enter."

Close safety hood and spin wheel.

After wheel stops, raise the safety hood.

Remove tire/wheel assembly from balancer, deflate tire and loosen the tire beads from the wheel, then rotate tire 180 degrees on the wheel.

Remount the tire/wheel assembly on the balancer with valve stem at TDC and press  "Enter."

Close safety hood and spin wheel.

After wheel stops, raise the safety hood.

With green arrows lit respectively, mark wheel when flashing “r” is at TDC, and mark tire when flashing “t” is at TDC.

If imbalance is less than 0.25 oz. for wheel or tire there will be no benefit in proceeding.

If imbalance is excessive in tire or wheel only, replace unit and rebalance.

Remove wheel from balancer.

Deflate tire, loosen the tire beads from the wheel, and rotate tire on the wheel to lineup the two marks.

OPT-1 balancing procedure is complete.

Balance the wheel. *Refer to the desired balance procedure.*

3.10 OPT-2 Optimizing Tire & Wheel Imbalances (Tire Not Mounted Procedure)



OPTimizing positions the wheel with respect to the tire, minimizing the amount of correction weight required. Use OPT-2 when tire has not been mounted on wheel.

Mount bare wheel on spindle shaft with the valve stem at TDC.

Enter Standard wheel dimensions.

Press the  “Optimize” button twice.

Press the  “Enter” button to begin procedure.

Display shows “Put” “Top,” and the valve stem is flashing. Rotate the wheel until the valve stem is at TDC and press the “Enter” button.

Close safety hood and spin wheel.

After the wheel stops, raise the safety hood.

Remove wheel from balancer and mount tire on wheel.

Remount the tire/wheel assembly on the balancer with the valve stem at TDC and press the “Enter” button.

Close safety hood and spin wheel.

After wheel stops, raise safety hood.

With green arrows lit respectively, mark wheel when flashing “r” is at TDC, and mark tire when flashing “t” is at TDC.

If imbalance is less than 0.25 oz. for wheel or tire there will be no benefit in proceeding.

If imbalance is excessive in tire or wheel only, replace unit and rebalance.

Remove tire/wheel assembly from balancer.

Deflate tire, loosen the tire beads from the wheel, and rotate tire on the wheel to lineup the two marks.

OPT-2 balancing procedure is complete.

Balance the tire/wheel assembly. *Refer to the desired balance procedure.*

3.11 Patch Balance® Procedures

Use Patch Balance® procedure when weighted balance patches are to be cemented to the inside of the tire. Weight balance patches are recommended for oversize light truck tires that require excessive weight on the rim.

Before performing Patch Balance® procedure, perform Standard Dynamic rim entry and spin steps to determine which patch balancing procedure should be used:

Find TDC for the left plane.

If the right plane weight position indicator is lit solid and not blinking, perform a Static Patch Balance.

If the right plane weight position indicator is blinking, perform a Dynamic Patch Balance.

Static Patch Balance® (Single Weighted Balance Patch)

A weighted balance patch will be placed in the center of the tread area inside of the tire as shown below:

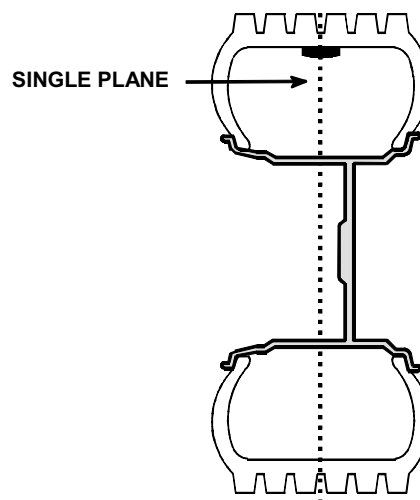

Mount wheel.

Enter Standard wheel dimensions.

Press the  "Static/Dynamic" button to select STATIC mode.

Press the  "Standard/ALU" button twice to select adhesive weight mode.

Measure inside tire diameter using a tape measure or tool, 221-527-1, just below tread depth as shown below:

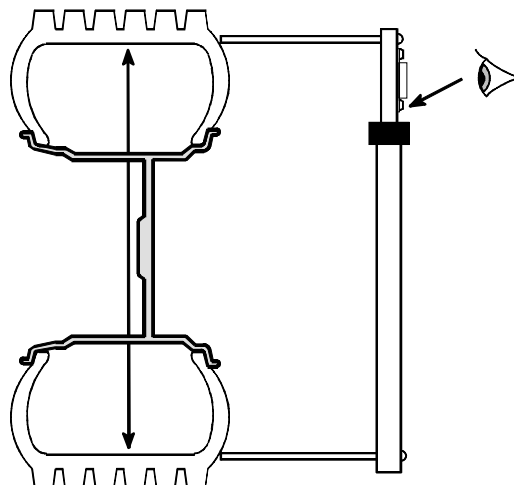

Enter inside tire diameter using the diameter knob.

Close safety hood and spin wheel.

After wheel stops, raise the safety hood.

Rotate wheel to TDC and mark tire and wheel for weighted patch(es) at location as shown below:

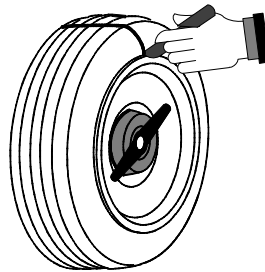

If necessary, use  "Left Plane Split Weight®" or  "Right Plane Split Weight®" to split weight.

Remove wheel from balancer and dismount tire from wheel.

Install weighted balance patch centered on inside of tire at mark as instructed by manufacturer's instructions.

Mount the tire onto wheel and align marks.

Press the  "Standard/ALU" button twice to select standard clip-on weight mode.

Balance. Verify balance condition by spinning again.

NOTE: Weight digits blink if the force signals are larger than the measurement range of the balancer. If this occurs, check for wheel being not properly centered on spindle shaft. If wheel is centered, apply the displayed weights. The blinking weights indicate that a second spin and additional weight(s) may be required to get zero imbalance. Refer to "Correcting Large Imbalances," page 52.

Dynamic Patch Balance® (Two Weighted Balance Patches)

Weighted balance patches will be placed on the inside of the tire at the edge of the tread area beside the sidewall as shown below:

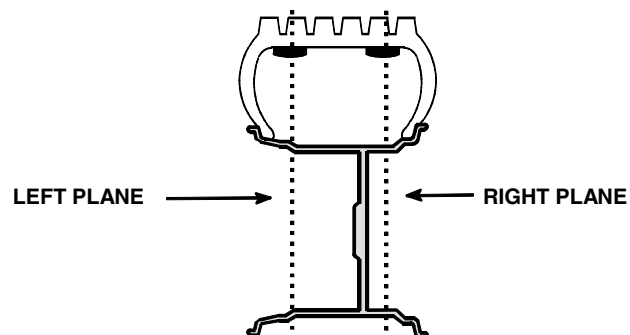

NOTE: Weighted balance patches should be installed only in tread area. Do not install weighted balance patches near sidewall or shoulder of tire.

Mount wheel.

Press the  “Static/Dynamic” button to select DYNAMIC mode.

Press the  “Standard/ALU” button to select two adhesive weights mode.

Place inner Dataset[®] arm on rim under the desired left patch location and tap foot pedal.

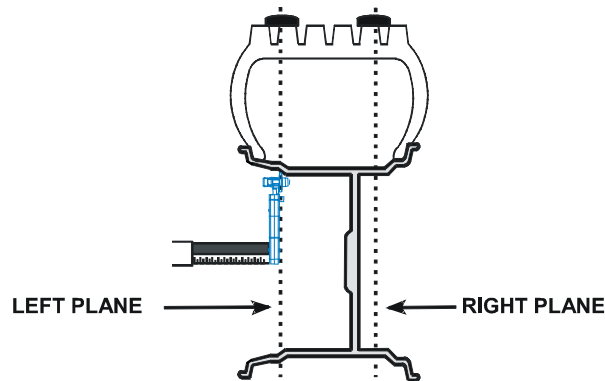

Place inner arm on rim under the desired right patch location and tap foot pedal.

Measure inside tire diameter using a tape measure or tool, 221-527-1, just below tread depth, and enter reading as inside tire diameter for the left plane using the diameter knob. *Refer to illustration on page 44.*

Close safety hood and spin wheel.

After wheel stops, raise the safety hood.

If necessary, use  “Left Plane Split Weight[®]” to split weight(s).

Find TDC for left plane weighted balance patch(es) and mark tire for patch placement.

Find TDC for right plane weighted balance patch(es) and mark tire and wheel for patch placement and reassembling.

Remove wheel from balancer and dismount tire from wheel.

Install left weighted balance patch(es) at mark(s) as instructed by manufacturer's instructions.

Install right weighted balance patch(s) at mark(s) as instructed by manufacturer's instructions.

Mount tire onto wheel and align marks.

Verify balance condition by spinning again.

Balance the wheel. *Refer to the desired balance procedure.*

| | |
|--------------|--|
| NOTE: | Weight digits blink if the force signals are larger than the measurement range of the balancer. If this occurs, check for wheel being not properly centered on spindle shaft. If wheel is centered, apply the displayed weights. The blinking weights indicate that a second spin and additional weight(s) may be required to get zero imbalance. <i>Refer to “Correcting Large Imbalances,” page 52.</i> |
|--------------|--|

4. BALANCING FEATURES AND OPTIONS

4.1 Servo-Stop

Servo-Stop Wheel Weight Positioning

After the balance spin, the wheel assembly will automatically locate, brake, and hold the wheel assembly in the correct weight installation location.

Disabling Servo-Stop

Press the red  "Stop" button to disable servo-stop.

Turning On Servo-Stop

Press the green  "Start" button, or step on the foot pedal with the safety hood in the raised position to turn on servo-stop.

Servo-Stop Aided Clip-On Weight Placement

Spin the wheel using Clip-On Weights selection. The wheel will stop with the clip-on weight location at TDC.

Pressing the green  "Start" button or stepping on the foot pedal will automatically rotate the wheel to place the next weight location at TDC.

Servo-Stop Aided Adhesive Weight Placement

The inner Dataset[®] arm can be used to assist in proper placement of adhesive weights. Using dimensional information previously obtained, the display identifies the exact location of the weight plane and the current position of the inner Dataset[®] arm.

Wheel dimensions must be entered using the inner automatic Dataset[®] arm while in the desired balance mode. Servo aided weight placement is not allowed if wheel dimensions were changed by turning the knobs, or if dimensions were entered using the automatic inner Dataset[®] arm before changing the balance mode (i.e. changing from clip-on mode to clip-on/adhesive mode).

Spin the wheel using Mixed Weights or Adhesive Weights selection. The wheel will stop with one of the adhesive weight locations at BDC.

Shape the weight to a contour similar to the curve of the rim.

With one of the weight locations at BDC and servo on, pull the inner Dataset[®] arm out from the base.

The wheel will automatically rotate to place the weight location where the inner arm will contact the rim.

The "target" inner arm distance will be shown on the rim distance dimension.

If a weight is being placed on the left plane, the live inner arm distance will be flashing on the right weight display and the amount of weight to be placed is shown on the left weight display. The displays are reversed if a weight is being placed on the right plane.

Continue to pull out the inner arm until the "live" distance equals the target distance.

Maintaining that distance, rotate the Dataset[®] arm toward the inner rim surface, and then apply the adhesive weights to the rim by pressing the adhesive weight release tab.

Return the inner Dataset® arm to the home position. The wheel will automatically rotate to return the weight location back to BDC.

Press  "Start" to advance to the other weight locations, and place all adhesive weights similarly.

NOTE: The balancer assumes that the weight being placed is the one located at BDC when the inner arm is lifted. If there is a weight located at BDC on both the right and left planes, lift the inner arm to enter weight placement mode, then press  "Next" to select the plane that you wish to display.

NOTE: To cancel weight placement mode and use the inner Dataset® arm for wheel dimension entry, return the inner arm to home position and press the  "Stop" button to disable servo.

4.2 Locate the Adhesive Wheel Weights Using the Dataset® Arm Pointer Disk Edge

Find BDC (6 o'clock position) by turning the wheel until the Green Arrow of the TDC indicator is blinking and the center LED is blinking on the weight indicator. In this position, an adhesive weight has to be attached at BDC.

Inside of Wheel (Single Row of Adhesive Weights)

When using a single row of adhesive weights, place them so **they are at the right edge** of the pointer disk edge as illustrated below.



WEIGHTS ON
RIGHT EDGE OF
WEIGHT PLANE
AS MEASURED
BY DATASET®
ARM

Inside of Wheel (Double Row of Adhesive Weights)

When using a double row of weights, place them so **they are at the right edge** of the pointer disk edge as shown below. Two rows are recommended when the required weight is more than 3 ounces. Make each strip of weights as close as possible to one-half the required amount of weight.



WEIGHTS ON
RIGHT EDGE OF
WEIGHT PLANE
AS MEASURED
BY DATASET®
ARM

4.3 Quick-Thread™ Feature

Quick-Thread™ is an “intelligent” DC drive motor control feature that allows motor assisted threading for fast installation and removal of the DSP9200 wing nut.

 **WARNING:** Keep clear of clamping components during Quick-Thread® shaft rotation.

Lift the wheel assembly onto the shaft as normal without threading on the wing nut. With your left hand, hold the rim over the cone to remove the weight of the rim from the spindle and to allow maximum Quick-Thread® wing nut travel. Place the wing nut on the spindle and rotate one full turn onto the spindle threads. With your right hand, hold one handle of the wing nut while you are still lifting the rim.

NOTE: Heavier wheel assemblies may require extra lifting to prevent the software limited motor torque control from stopping the rotation of the spindle.

Tap the foot pedal twice and the spindle will rotate to install the wing nut to save threading time.

The direction of spindle rotation toggles each time it is used. For normal operation, spindle rotation will begin in the correct direction for wing nut installation. A single tap within the first three seconds of rotation will reverse the direction of rotation. A single tap after the first three seconds of rotation will stop rotation.

Quick-Thread® spindle rotation will stop when the clamping components contact the wheel, or when the foot brake (*refer to “Spindle-Lok® Feature,” page 50*) is applied for more than half of a second.

 **CAUTION:** Quick-Thread® does not tighten the wing nut! In Quick-Thread® rotation, torque allowed is minimal. Therefore, you must still perform the final tightening of the wing nut.

NOTE: Also because of the software limited torque control, you must **loosen** the wing nut before Quick-Thread® will remove it.

Quick-Thread® will not operate if:

You are in “Diagnostics,” “Setup,” or all calibration procedures except “Servo-Stop.”

Either Dataset® arm is out of its “home position.”

Inflation Station hose is out of its “home position.”

4.4 Motor Drive/Servo-Stop

The intelligent DC motor drive on the DSP9200 is able to position and hold the tire assembly in position for weight application, apply different amounts of torque, and control the speed and direction of the spindle.

Servo-Stop/Servo-Push

With Servo-Stop, when the “Start” button is pushed with the hood in the raised position, while weights are showing, the motor will automatically rotate the wheel to the next weight plane and hold the assembly in position for weight application.

Servo-Push allows pushing the wheel (approximately 1/8 of a revolution) to cause the intelligent DC motor drive to automatically rotate the wheel to the next weight placement position. Pressing the “START” key may still be used for this function.

4.5 Spindle-Lok[®] Feature

If the balancer is equipped with the Spindle-Lok[®], depressing the foot pedal will lock the spindle. Locking the spindle will stabilize the wheel for attaching weights at precise locations, and for tightening and loosening of the wing nut. Do not use the Spindle-Lok[®] as a brake to stop a spinning wheel.

⚠ CAUTION: Using the Spindle-Lok[®] to stop a spinning wheel may result in personal injury or damage to the balancer.

4.6 Hood Close Autostart Feature

The balancer can be set to automatically spin the wheel when the safety hood is closed. After a spin, the hood must be lifted completely before the balancer will autostart again.

Hood Close Autostart feature can be enabled or disabled in the setup procedure.

4.7 Loose Hub Detect Feature

If the wheel slips on the spindle shaft during the spin, the balancer automatically brakes the shaft to a stop and displays “LOO SE” on the weight amount indicators.



If the “LOO SE” hub error occurs:

- Lift the safety hood.
- Retighten the wing nut.
- Spin the wheel again.

If the wing nut feels like it is already tight, the shaft braking to a stop caused the wing nut to retighten. Make sure that the wing nut is fully tightened and then re-spin the wheel.

To override the loose hub detect feature:

Decrease the wheel diameter knob setting to the minimum value allowed while in the STANDARD procedure, then continue to turn the wheel diameter knob counterclockwise until the wheel diameter digits change to zero. It will take approximately one full turn of the knob while the “ratcheting” sound is occurring (at minimum value) for this to occur.

When the balancer is first turned “ON,” the diameter digits will default to zero (the loose hub detect feature is overridden).

4.8 Blinding and Rounding

The balancer can display either an “actual” or “blinded and rounded” amount of imbalance.

“Blind” is a tolerance or amount of imbalance required before an imbalance amount is displayed. “Rounded” allows the balancer to display weight imbalance to the closest increment. The blinded and rounded values can be changed by the service representative.

| Blind Settings | | Rounding Settings | |
|----------------|------|-------------------|-----|
| oz | gm | oz | gm |
| 0.00 | 0.0 | 0.00 | 0.0 |
| 0.15 | 4.0 | 0.05 | 1.0 |
| *0.29 | 8.0 | *0.25 | 5.0 |
| 0.58 | 16.0 | | |



* Factory settings

When using the  “Static/Dynamic” button, STATIC or DYNAMIC can be selected to include the middle display LED (as shown below). When the middle display LED is on, the blind and rounding are disabled. The actual amounts of imbalance, for the selected mode, will be displayed. (The blind and rounding are disabled.)



For example: Pressing the  “Static/Dynamic” button from DYNAMIC LED lit to the DYNAMIC plus the middle position LED lit, will display the actual imbalance amounts on the inner plane and outer plane weight amount indicators.

4.9 Split Weight[®] Feature

Pressing either the  “Left Plane Split Weight[®]” or the  “Right Plane Split Weight[®]” button will change the required imbalance correction weight amount into two smaller size weights. The angle is adjusted by the balancer to produce the non-rounded correction called for by the single weight before the split. This provides exact imbalance correction without weight trimming. The non-rounded imbalance is split regardless of whether blind and rounding are enabled. For this reason, Split Weight[®] is more accurate than applying a single weight with the blind and rounding enabled.

Split Weight[®] is especially useful when the imbalance amount is large or unavailable, such as 6.0 ounces. Split Weight[®] eliminates the error caused by placing two 3.0 ounce weights side-by-side, which would leave a substantial residual imbalance:

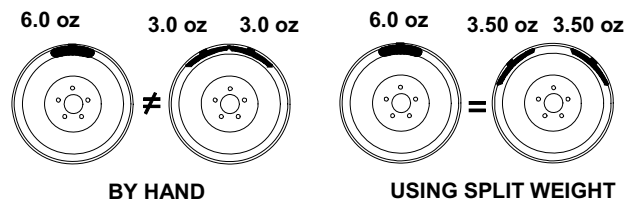

Use the “Left Plane Split Weight[®]” or “Right Plane Split Weight[®]” when the weight location interferes with a hubcap or trim ring, when one weight is too large, to avoid weight trimming, or to substitute for a weight size that is out of stock.

Split Weight® Operation

Press either the left or the right “Split Weight®” button to divide that plane’s required weight into two smaller weights.

Press the left or right  “Split Weight®” button repeatedly to gain additional size and location choices. Continued presses will return display to single weight amount and angle.

Each time a “Split Weight®” button is pressed, the two weights are increased to the next largest weight size and are placed (fanned-out) further down the rim. The display shows the amount and placement angle for both weights at the same time. After all Split Weight® choices have been displayed, pressing the “Split Weight®” button returns the display to the original single weight amount and angle.

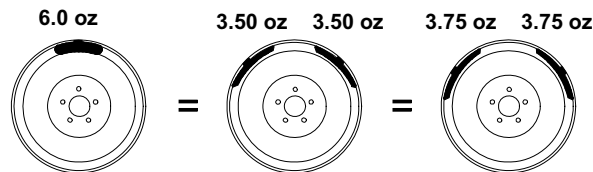

Correcting Large Imbalances

“Split Weight®” can also be used to apply three weights when needed. For example, a large wheel may require 6.75 ounces. Not only is this size unlikely to be in the weight tray, but splitting 6.75 ounces would likewise result in large weights. In this case, apply one-third of the called for weight (in this case 2.25 ounces) at the 6.75 ounce weight location and spin again. The display will now call for a 4.5 ounce weight to be placed on top of the 2.25 ounce weight. Press the  “Split Weight®” button (to fan out the two weights) until they clear the previously applied 2.25 ounce weight. Then place the two indicated ounce weights on either side of the 2.25 ounce weight (as illustrated below) using the TDC display indicators.

Splitting 1 Large Weight into 3 Smaller Weights

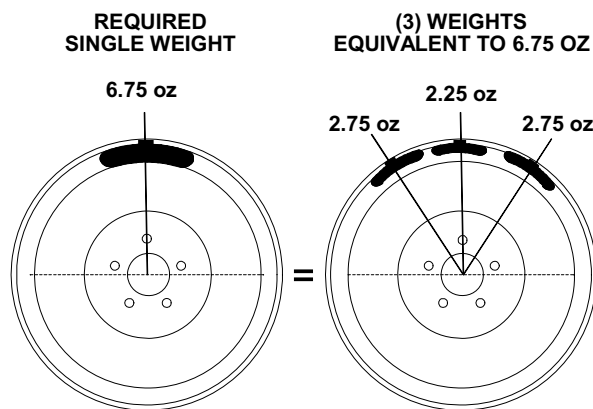

4.10 Split Spoke[®] Feature

Split Spoke[®] requires the optional inner Dataset[®] arm.

When in “mixed weight” or “adhesive weight modes,” (dynamic or static), correction weights can be hidden behind the spokes of a wheel.

Move the optional inner Dataset[®] arm to left weight plane position. Enter the data by pressing the foot pedal.

Move the optional inner Dataset[®] arm to the far right weight position, using the downward arm position. Enter the data by pressing the foot pedal.

The display is now flashing “SPO -1-.” Without returning the optional inner Dataset[®] arm to the home position, rotate the wheel and place the arm so that it is centered behind a spoke. Enter the data by pressing the foot pedal.

The display is now flashing “SPO -2-.” Rotate the wheel to position the optional inner Dataset[®] arm behind an adjacent spoke (nearest spoke in either direction). Enter the data by pressing the foot pedal.

Return the optional inner Dataset[®] arm to the home position. Close safety hood.

Press the green  “Start” button if “Hood Autostart” is disabled.

After wheel comes to a complete stop, raise the safety hood.

Place left plane weight (if in DYNAMIC mode) per the balance procedure being performed.

Notice that there are two weights on the right plane bar graph. The amount shown depends upon which weight is currently located at the correct position to place the weight. If the wheel is not positioned to locate either weight, no amount is shown “---.”

| |
|---|
| NOTE: There will be only one weight on the right plane if all of the correction weight can be placed behind one spoke. |
|---|

With the servo enabled, attach the adhesive weight behind the first spoke using the weight amount shown.

Press the “Start” button with the hood raised to servo to the location for the second spoke. The display automatically changes to the amount of the second weight.

Attach the adhesive weight behind the second spoke.

Verify by spinning again. Both planes should be zero.

Re-entering Similar Wheel after Split Spoke[®] is Enabled

Once Split Spoke[®] mode is enabled, use the  “Next” button to input the spoke orientation of the other three wheels from a set to avoid re-measuring the weight plane dimensions each time.

Press the  “Stop” button to disable servo and avoid starting servo aided weight placement mode. Mount the next wheel.

Move the optional inner Dataset[®] arm to a position centered behind a spoke, using the downward arm position to align the spoke location.

Press the  “Next” button. The display flashes “Put SPO.”

Enter the spoke location by pressing the foot pedal (no need to enter a second spoke).

Return the optional inner Dataset[®] arm to the home position. Close safety hood. Press the green  “Start” button if “Hood Autostart” is disabled. Continue the balancing procedure.

Placing Hidden Weight Forward of Obstructions

On some wheels, it may be possible to hide right weight plane adhesive weights inside of the hollow spoke. However, wheel construction may make it impossible to enter the right weight plane to the desired location with the optional inner Dataset[®] arm.

The following example is in the mixed weight mode.

Move the optional inner Dataset[®] arm to left plane position. Enter the data by pressing the foot pedal.

Enter the left weight plane to the best possible position, using a tape measure. This distance must be in millimeters (convert inches to millimeters by multiplying by 25.4).



Measure the weight plane diameter manually, using caliper.



| | |
|--------------|--|
| NOTE: | This may need to be done before the wheel is mounted on the DSP9200. |
|--------------|--|

Add the measurement from the left weight plane to the desired right weight plane to the distance to the inner rim lip and enter this new dimension manually.

Enter the weight plane distance (mm) and diameter (in) manually. Close safety hood.

Press the green  "Start" button if "Hood Autostart" is disabled.

After wheel comes to a complete stop, raise the safety hood.

Place left plane weight (if in DYNAMIC mode) per the balance procedure being performed. Refer to "Balancing a Wheel," page 19.

Press the green  "Start" button with the safety hood in the raised position and the DSP9200 will servo to the location for the right adhesive weight plane (dynamic) or the static adhesive weight plane (static), aligned with the first spoke.

With the servo enabled, attach the adhesive weight behind the first spoke using the weight amount shown on the CRT.

Press the green  "Start" button with the safety hood in the raised position and the DSP9200 will servo to the location for the second spoke.

Attach the appropriate weight as displayed on the console.

Verify balance condition by spinning again.

All weight plane displays should show “zero.” Split Spoke® balancing procedure is complete.

4.11 Automatic Weight Recalculation and Dimension Preservation

When dialing a rotary encoder knob, each click of the knob (changing a dimension) causes the weights to be recalculated. The benefit is that without re-spinning, you have the unique ability to relocate the desired weight locations and see the resulting weights and placement angles updated in real-time.

When attempting to dial in a value not allowed or exceeding a limit, the rotary encoder knob will make a “ratcheting” sound. For example: Trying to dial in a wheel width under 1.5 inches, will cause a “ratcheting” sound.

When entering STANDARD, MIXED WEIGHTS, or TWO ADHESIVE WEIGHTS MODE, the last dialed in dimensions for that procedure are recalled and displayed. The weight amounts and angles for these dimensions are recalculated and displayed. The benefit is that without re-spinning the wheel, you have the unique ability to switch between balancing procedures to determine the best combination of weight types for the tire/wheel assembly.

| | |
|--------------|--|
| NOTE: | The exception to this rule is when changing a dimension in STANDARD and then entering an ALU mode. The last ALU dimensions used are replaced by new dimensions based on the new STANDARD dimensions. |
|--------------|--|

Any change between STATIC and DYNAMIC, or Enabling/Disabling the “blind” and “rounding” also preserves dimension information and recalculates the weights.

4.12 Storing and Recalling Wheels

The balancer can store and recall SETUP information, balance procedure, and wheel dimensions for up to four specific wheels. Storing and recalling can also be used to allow up to four technicians to use the wheel balancer at the same time.

Storing a Wheel into Memory

Enter SETUP information (oz/gm, diameter in/mm, and width in/mm), balance procedure, and wheel dimensions for a specific wheel.

Press the  “Enter” button. -0- appears indicating that the store/recall mode is activated, but no wheel has been selected.

Press the  “Next” button until wheel 1, 2, 3, or 4 is selected.

Press and hold the  “Enter” button for a minimum of two seconds to store wheel.

A confirmation beep will confirm that the wheel has been stored into memory and wheel index turns into weights for the recalled wheel.

Recalling a Wheel from Memory

Press the  “Enter” button. -0- appears indicating that the store/recall mode is activated, but no wheel has been selected.

Press the  “Next” button until stored wheel 1, 2, 3, or 4 is selected.

Press the  “Enter” button briefly (less than two seconds) to recall stored wheel dimensions and SETUP information.

5. MAINTENANCE AND CALIBRATION

5.1 Cleaning the Unit

When cleaning the unit, use window cleaning solution to wipe off the display console and cabinet. Do not spray window cleaning solution directly onto control panel. **Do not hose down the unit.** This could damage the electrical system.

5.2 Spindle Hub Face and Shaft Maintenance

Keep the spindle shaft and wing nut threads clean and lubricated. Lubricate the shaft without contaminating the hub face. Run the edge of a rag between the threads while the spindle is slowly turned by the motor drive. If any signs of dirt or debris appear on the spindle threads, the spindle should be cleaned immediately prior to mounting a wheel.

 **CAUTION:** Failure to clean spindle properly will result in a loss of clamping force.

Lubricate the shaft with a coating of light lubricant with Teflon[®] such as Super Lube[®] by Loctite[®] after cleaning. Do not lubricate the spindle hub face mounting surface. This could cause slipping between the wheel and the hub face. Keep the hub face mounting surface clean and dry.

5.3 Mounting Cone Maintenance

Keep the mounting cones clean and lubricated. Periodically lubricate with a coating of rust preventative to minimize corrosion. Spray lubricants, such as PS/2 or WD-40, are recommended.

Do not use cones in any way that is not described in this operation manual. This could cause damage to the mounting cone and not allow for proper mounting of the wheel. Refer to “Mount the Wheel on the Spindle Shaft,” page 19.

5.4 Identifying Software Version and Serial Number

If a problem arises, have your software version number and the balancer serial number at hand **before calling for service**. This will prevent the need for a second phone call.

The serial number is located on the serial plate label on the back of the balancer cabinet.

To access the software version number, press and hold the  “Enter” button while turning the machine “ON.” The left weight digits display the balancer model as determined by the configuration jumpers.

“920” Indicates a DSP9200 (No Auto Dataset[®] arms)

“92d” Indicates a DSP9200 (Inner Auto Dataset[®] arm only)

“2dd” Indicates a DSP9200 (Inner and Outer Auto Dataset[®] arms)

The right weight digits display the software version number.

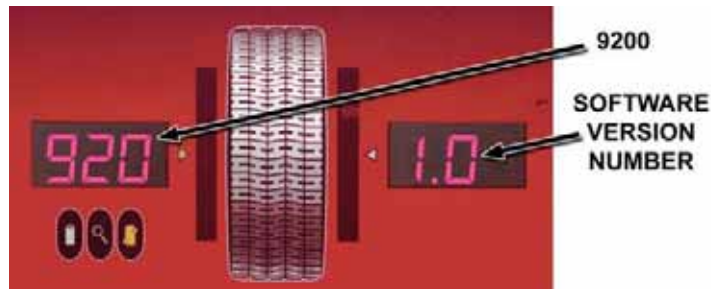

This manual provides operating instructions for the DSP9200 wheel balancer with software revision 1.0 and higher.

5.5 Calibration Procedures

“Calibration” can be selected by pressing the  “Setup/Cal” button.

Store the calibration weight, 65-72-2, in the threaded hole on the back of the control panel support.



Dataset[®] arm calibration requires the optional calibration tool, 221-602-1.

Quick Cal Check

Begin with balancer “OFF,” then turn “ON.”

Attach cal weight to either side of one of the two holes in the hub faceplate.

Lower hood and press the  “Start” button to spin. Display shows “CAL RDY” or “CAL ERR.”

| | |
|-------|---|
| NOTE: | If “CAL ERR” is displayed, the balancer needs to be recalibrated. |
|-------|---|

Whichever side the cal weight was installed, a plane weight position indicator will be displayed.

Check angle accuracy by verifying that the cal weight stops at TDC (12 o'clock position). If cal weight is in a position other than TDC, perform calibration procedure.

Press the  “Next” button to show weights.

The Quick Cal™ Check is complete.

Balancer Calibration

Press the  "Setup/Cal" button once. "CAL" is displayed.



Press the  "Enter" button to begin calibration.

Do not install cal weight. Lower the hood and press the "Start" button to spin (if "Hood Autostart" is disabled).

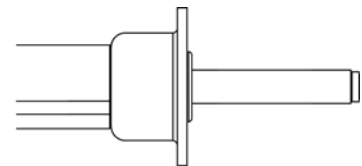

Install cal weight on left side of hub faceplate in either hole, align cal weight at TDC, and press the  "Enter" button. Spin.

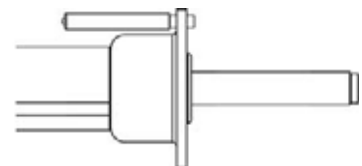

Move cal weight to right side of hub faceplate in same hole.

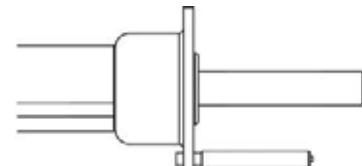
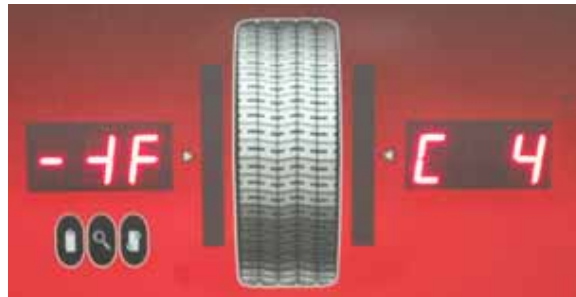



Spin, display reads "CAL RDY."



Inner Dataset[®] Arm (Calibration Tool, 221-672-1, Required)

Press  "Setup/Cal" button once. "CAL" is displayed.

Press  "Next" button. "CAL" is displayed at inner Dataset[®] arm location, and "---]" is displayed if equipped with outer Dataset[®] arm.

Press  "Enter" to begin calibration. The step numbers are shown on the display, starting with "Stp -1-." Each step is described below.

| | |
|-------|--|
| NOTE: | Turn the distance dimension knob to backup to a previous cal step. |
|-------|--|

Verify that the inner arm is not extended, is in the "home" position, and is not moving. Tap the foot pedal once or press "Enter."

Place the calibration tool on the shaft, using the spindle shaft slot located closest to the middle of the calibration tool, as shown. Rotate the calibration tool slowly by hand, clockwise until there is a beep, and the step number changes to "-3-."

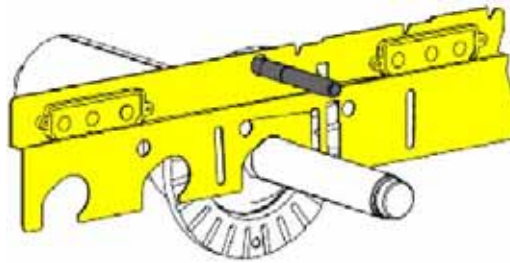

Position the calibration tool parallel to the floor. Tap the foot pedal once or press "Enter."

Place the inner Dataset[®] arm at upward position "1" as shown. Tap the foot pedal once or press "Enter."

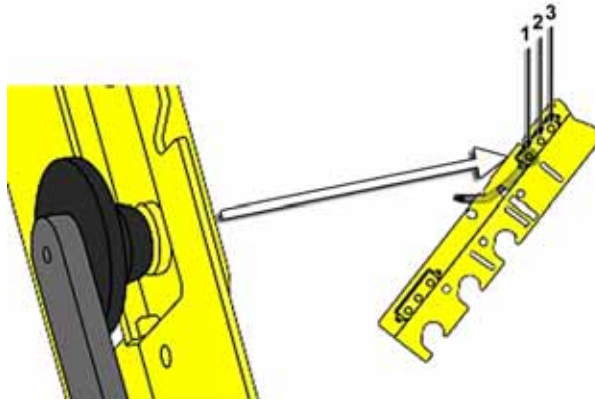

Move the inner Dataset[®] arm to upward position "2." Tap the foot pedal once or press "Enter."

Move the inner Dataset[®] arm to upward position "3." Tap the foot pedal once or press "Enter."

Place the inner Dataset[®] arm at downward position “4.” Tap the foot pedal once or press “Enter.”

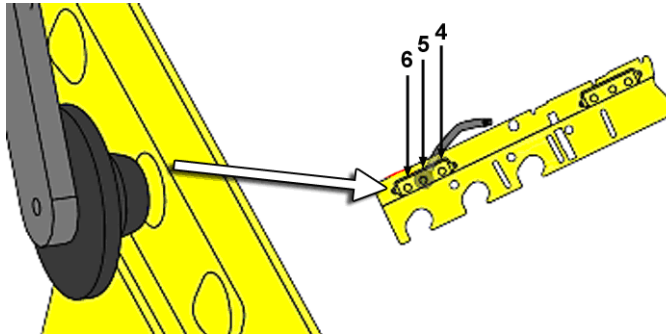

Move the inner Dataset[®] arm to downward position “5.” Tap the foot pedal once or press “Enter.”

Move the inner Dataset[®] arm to downward position “6.” Tap the foot pedal once or press “Enter.”

Remove the metal plug from the inner Dataset[®] arm and thread it back onto the calibration tool. Reinstall the black roller onto the inner Dataset[®] arm using the 1/8 inch Allen wrench.

Position the calibration tool parallel to the spindle shaft on the hub using the hub mounting slot as shown.

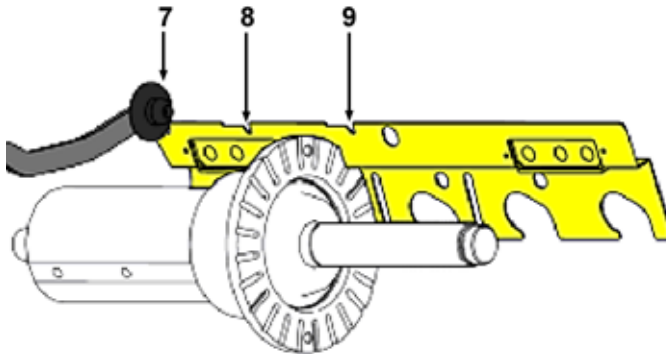

Place the inner Dataset[®] arm at the position “7.” Tap the foot pedal once or press “Enter.”

Move the inner Dataset[®] arm to position “8.” Tap the foot pedal once or press “Enter.”

Move the inner Dataset[®] arm to position “9.” Tap the foot pedal once or press “Enter.”

If optional outer Dataset[®] arm is not installed, calibration is complete. If optional outer Dataset[®] arm is installed, refer to “Outer Dataset[®] Arm,” page 62.

Outer Dataset[®] Arm (Calibration Tool, 221-672-1, Required)

With the hood in the raised position, verify that the outer arm is in the “home” position and that the arm and hood are not moving. Tap the foot pedal once or press “Enter.”

Place the calibration tool on the hub using the hub mounting slot as shown.

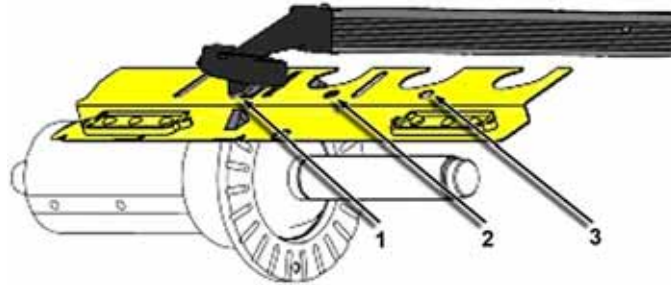

Place the outer Dataset[®] arm ball in hole position “1.” Tap the foot pedal once or press “Enter.”

Place the outer Dataset[®] arm ball in hole position “2.” Tap the foot pedal once or press “Enter.”

Place the outer Dataset[®] arm ball in hole position “3.” Tap the foot pedal once or press “Enter.”

Dataset[®] arm calibration is complete. “RDY” is displayed near the inner arm graphic to indicate that the inner Dataset[®] calibration passed. “RDY --]” is displayed on the weight digits to indicate that the outer Dataset[®] calibration passed.

6. GLOSSARY

Amplitude (Magnitude)

The amount of force or the intensity of the vibration.

Back Coning

When the wheel requires the cone to center the wheel on the balancer's shaft from the backside, primarily due to the chamfer of the wheel. Also referred to as Back-Cone Mounting.

Backspacing

The distance measured from the mounting face to the back edge of the wheel.

BDC

The abbreviation for bottom dead center also referred to as 6 o'clock.

Bead seating

The process of seating the tire to the rim bead seats. Bead seating preferably occurs just after the tire and rim have been assembled, but may gradually change and optimize over a longer period. If loaded with the GSP9200 load roller or driven, the position of the bead may optimize or always remain seated improperly, unless the tire is demounted, lubricated, and remounted. However, the load force and its' relatively short duration will not necessarily solve defective mounting of the tire bead seat to the rim seat.

Bolt Pattern Circle

The diameter of an imaginary circle drawn through the center of each lughole, and virtually always on the same centerline as the hub bore of the wheel.

Computerized Vibration Analyzer

A device used to determine the frequency of the vibration by isolating the vibrations with the greatest magnitude.

Cycle

One complete disturbance.

Dampen

To decrease the magnitude of a vibration or sound.

Dampers

Used to reduce the magnitude of a given vibration. Rubber is commonly used to isolate and dampen vibrations.

Dataset[®]

The inner and outer electronic arms on the GSP9200. By positioning the Dataset arms and entering data using the foot pedal, rim dimensions can be recorded for balancing.

Dynamic Balance

A procedure that balances the wheel assembly by applying correction weights in two planes so that up and down imbalance and side to side imbalance are eliminated.

Electro-Mechanical Ear

A device used much like a doctor's stethoscope and is for noise diagnosis problems only.

Forced Vibration

Vibrates when energy is applied.

Free Vibration

Continues to vibrate after the outside energy stops.

Frequency

The number of disturbances that occur per unit of time.

Front Coning

When the wheel requires the cone to center the wheel on the balancer's shaft from the front. Also referred to as Front-Cone Mounting.

Harmonic

A vibration that is identified by the number of occurrences per revolution. For example, a 1st harmonic vibration has a once per revolution vibration component.

Hertz

A unit of frequency: one disturbance per second.

Hub Centric

The wheel is centered using the center hole of the wheel.

Lateral Runout

The amount of side-to-side movement as the tire/wheel assembly rotates.

Lug Centric

The wheel is centered using the lugholes rather than the wheel center hole.

Magnitude (Amplitude)

The amount of force or the intensity of the vibration.

MatchMaker™

Allows the operator to match up four identical tires on identical rims, to achieve the optimal combination of match mounting.

Natural Frequency

The point at which an object will vibrate the easiest.

Order

The number of disturbances per cycle (rotation). For example, a 1st order vibration occurs once per cycle, and a 2nd order vibration occurs twice per cycle.

P, P/SUV, LT

"P Tires" refers to passenger tires, "LT Tires" refers to light truck tires, and "P/SUV Tires" refers to P-Rated sport utility vehicle tires.

Phase

The position of a vibration cycle relative to another vibration cycle in the same time reference.

Phasing

The cycle pattern of two or more vibrations that overlap and combine to increase the overall magnitude.

Pressure Ring

The accessory used to prevent the wing nut from contacting the wheel when on the balancer shaft.

Quick-Thread™

Motor assisted threading of the wing nut for quick installation and removal.

Radial Force Variation (RFV)

A term describing a measurement of the tire uniformity, under load, measuring the variation of the load acting toward the tire center.

Radial Runout

A condition where the tire and wheel assembly is slightly out of round forcing the spindle to move up and down as the vehicle rolls along a smooth surface.

Reed Tachometer

A mechanical device that uses reeds to indicate the frequency and magnitude of the vibration.

Resonance

The point where a vibrating component's frequency matches the natural frequency of another component.

Responding Component

The noticeable component that is vibrating.

Servo-Stop

The ability to locate varying positions of the tire/wheel assemblies and hold the position in place while correctional weights or OE-Matching marks are applied.

Source Component

A component causing another object to vibrate, such as a tire/wheel assembly.

Spindle-Lok[®]

A feature that locks the spindle in place by depressing the foot pedal.

Static Balance

A procedure that balances the wheel assembly using only a single weight plane.

TDC

An abbreviation for top dead center. Also referred to as 12 o'clock.

Torque Sensitive Vibration

The vibration occurs when accelerating, decelerating, or applying the throttle.

Total Indicated Reading (T.I.R.)

Data measurements taken by the load roller (measured in lbs. or kg) or Dataset[®] Arms (measured in inches or millimeters) representing the actual runout measured. The T.I.R. data represents the difference in value between the highest and lowest value measured.

Transference Path

The object(s) that transfer the frequency.

Vibration

A shaking or trembling, which may be heard or felt.

Wheel Diameter

Dimension measured on the inside of the rim at the bead seats.

Wheel Offset

The measured distance between the mounting face of the wheel and the centerline of the rim.

Wheel Width

Dimension measured on the inside of the rim between the bead seats.

HUNTER RESEARCH AND TRAINING CENTER



HUNTER . . . dedicated to service excellence through professional training

HUNTER TRAINING - Hunter operates the most advanced, up-to-date Training Center in the industry today.

The courses have been designed to meet the needs of new and experienced technicians who want to increase their mechanical and diagnostic capabilities. The low student-teacher ratio (average 7 to 1) and the emphasis on "hands-on" training (80% time in shop) create an excellent learning environment.

Highlights of the Hunter Training Center include:

- An instruction staff with over 100 years of shop, field, and teaching experience.
- Fully-equipped service bays.
- Classrooms equipped with modern teaching aids.
- The most up-to-date wheel alignment, balancing service and brake equipment on the market today.

Align 1 (Basic Alignment Theory and Practice) 3 day / 24 hrs

Students will learn basic wheel alignment service through classroom and hands-on practice. Pre-alignment services, wheel alignment angle theory and wheel alignment equipment operation are the focus of this course. Basic wheel alignment adjustments will be demonstrated and students will practice on vehicles in a shop environment.

Align 3 (Advanced Diagnostics and OE Procedures) 2-day / 16 hrs

This class focuses on using advanced diagnostic angles and measurements to determine damaged suspension and steering components. Techniques used in finding damaged parts are reinforced with classroom scenarios and hands-on labs designed to both challenge and further embed these much needed skills.

GSP9700 Certification 2-days / 16 hrs

This course combines the Rolling Smooth course with a certification program for Hunter Engineering's GSP9700 Road Force Measurement system. Students use hands-on practice with the GSP9700 to gain a proficiency level acceptable to be deemed certified.

HDT Alignment 1 (Fundamental Alignment) 3-day / 24 hrs

Classroom and shop practice is used to teach the basic elements of Class 8 truck wheel alignment. Students will learn the proper method to measure and correct the required basic alignment angles using state of the art equipment. Trailer alignment is included.

Align 2 (Advanced theory / Aftermarket Adjustment) 2-day / 16 hrs

Modified vehicle wheel alignment is the focus of this course. Students learn how to use alignment angles to achieve vehicle handling performance in conjunction with ride height kits and modified tire/wheel packages. Aftermarket alignment adjustment kits are discussed and demonstrated.

Performance Tire (Basic and Advanced Tire Changing) 1-day 8 hrs

Students will learn basic terminology and theory related to servicing tires and wheels. Students learn the proper techniques for changing tires on tulip clamp and table top tire changer designs. This course covers the proper tire changing techniques for low profile tires, run flat designs, and tire/wheel assemblies using TPMS.

Rolling Smooth (Basic & Advanced vibration theory) 1-day / 8 hrs

This course offers a study of vehicle vibration specific to wheel speed. The student will learn basic vibration terminology and vibration theory. Shop activities include the measurement of Road Force Variation, wheel runout and balance. Additional diagnostic tools are discussed.

HDT Alignment 2 (Advanced Alignment) 2-day / 16hrs

The student will understand the cause and affect of basic alignment angles relative to ride quality, performance and tire life. Classroom and shop practice are used to learn the proper use of diagnostic alignment angles. Additional adjustment techniques and alignment system operation are explored in both the classroom and lab environment. Busses and RVs are discussed.



Hunter University's eLearning courses are designed for all student levels and can be used as an integral supplement to instructor-led training courses. In-depth information, detailed graphics, video and modular segments assist the participant in expanding their knowledge base at a self-determined level. Go to www.hunter.com and click on **TRAINING**.

For further information about other classes offered or to schedule into a class, simply call the Hunter Research and Training Center at 1-800-448-6848.